

ALUMIBEL

Comércio de Alumínio e Acessórios

Catálogo de produtos

ALUMIBEL

BARRAS
RETANGULARES

Comércio de Alumínio e Acessórios

BARRAS RETANGULARES

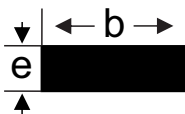

PERFIL ALCANN	PESO LINEAR (kg/m)	F.S	mm		pol	
			b	.	b	.
BAR-012	0,109	17	12,70	3,18	1/2	1/8
BAR-047	0,163	12	12,70	4,76	1/2	3/16
BAR-086	0,217	10	12,70	6,35	1/2	1/4
BAR-124	0,326	8	12,70	9,52	1/2	3/8
BAR-013	0,136	16	15,88	3,18	5/8	1/8
BAR-049	0,204	12	15,88	4,76	5/8	3/16
BAR-088	0,272	9	15,88	6,35	5/8	1/4
BAR-125	0,408	7	15,87	9,52	5/8	3/8
BAR-014	0,164	16	19,05	3,18	3/4	1/8
BAR-050	0,245	11	19,05	4,76	3/4	3/16
BAR-089	0,326	9	19,05	6,35	3/4	1/4
BAR-126	0,488	7	19,05	9,53	3/4	3/8
BAR-015	0,191	15	22,22	3,18	7/8	1/8
BAR-158	0,656	6	19,05	12,7	3/4	1/2
BAR-052	0,286	11	22,22	4,76	7/8	3/16
BAR-090	0,38	8	22,22	6,35	7/8	1/4
BAR-016	0,218	15	25,40	3,18	1	1/8
BAR-053	0,326	11	25,40	4,76	1	3/16
BAR-091	0,435	8	25,40	6,35	1	1/4
BAR-019	0,273	15	31,75	3,18	1.1/4	1/8
BAR-054	0,408	10	31,75	4,76	1.1/4	3/16
BAR-093	0,544	8	31,75	6,35	1.1/4	1/4
BAR-132	0,815	6	31,75	9,53	1.1/4	3/8
BAR-022	0,327	14	38,1	3,18	1.1/2	1/8
BAR-057	0,490	10	38,10	4,76	1.1/2	3/16
BAR-096	0,653	8	38,10	6,35	1.1/2	1/4
BAR-164	1,306	4	38,10	12,70	1.1/2	1/2
BAR-027	0,436	14	50,80	3,18	2	1/8
BAR-061	0,653	10	50,80	4,76	2	3/16
BAR-100	0,870	8	50,80	6,35	2	1/4
BAR-137	1,304	5	50,80	9,35	2	3/8
BAR-168	1,741	4	50,80	12,70	2	1/2
BAR-032	0,654	14	76,20	3,18	3	1/8
BAR-106	1,306	7	76,20	6,35	3	1/4
BAR-175	2,611	4	76,20	12,70	3	1/2
BAR-036	0,872	14	101,60	3,18	4	1/8
BAR-110	1,741	7	101,06	6,35	4	1/4
BAR-149	2,611	5	101,06	9,52	4	3/8
BAR-180	3,483	4	101,06	12,70	4	1/2
BAR-112	2,177	7	127,00	6,35	5	1/4

ALUMIBEL

Comércio de Alumínio e Acessórios

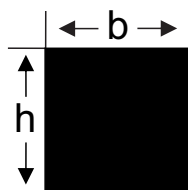

BARRAS QUADRADAS

PERFIL ALCANN Nº	PESO LINEAR (kg/m)	F. S.	h=b	
			mm	pol.
VER-4001	0,097	14	6,00	-
VER-4002	0,108	14	6,35	1/4
VER-4003	0,170	11	7,93	5/16
VER-4004	0,173	11	8,00	-
VER-4006	0,246	9	9,52	3/8
VER-4007	0,332	8	11,11	7/16
VER-4008	0,435	7	12,70	1/2
VER-4011	0,680	5	15,87	5/8
VER-4013	0,980	5	19,05	3/4
VER-4015	1,334	4	22,22	7/8
VER-4017	1,742	3	25,4	1
VER-4018	2,203	3	28,57	1.1/8
VER-4019	2,722	3	31,75	1.1/4
VER-4022	3,920	2	38,1	1.1/2
VER-4023	4,595	2	41,27	1.5/8
VER-4024	5,335	2	44,45	1.3/4
VER-4026	6,969	2	50,8	2

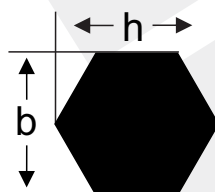

BARRAS SEXTAVADAS

PERFIL ALCANN	PESO LINEAR (kg/m)	F. S.	mm		pol.
			b	h	b
VER-6003	0,212	9	9,52	11	3/8
VER-6004	0,290	8	11,11	12,83	7/16
VER-6005	0,378	7	12,70	14,66	1/2
VER-6006	0,479	6	14,28	16,5	9/16
VER-6007	0,590	5	15,87	18,33	5/8
VER-6009	0,851	4	19,05	22,00	3/4
VER-6011	1,558	4	22,22	25,66	7/8

ALUMIBEL

BARRAS
REDONDAS

Comércio de Alumínio e Acessórios

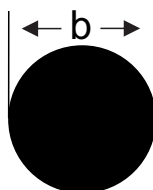

BARRAS REDONDAS

PERFIL ALCANN	PESO LINEAR (kg/m)	F.S	DIAMETRO	
			mm	pol.
VER-004	0,133	11	7,93	5/16
VER-007	0,193	9	9,52	3/8
VER-009	0,262	8	11,11	7/16
VER-011	0,342	7	12,70	1/2
VER-012	0,433	6	14,28	9/16
VER-014	0,536	5	15,87	5/8
VER-016	0,772	5	19,05	3/4
VER-018	1,050	4	22,22	7/8
VER-020	1,205	4	23,81	15/16
VER-021	1,371	3	25,40	1
VER-024	1,735	3	28,57	1.1/8
VER-027	2,140	3	31,75	1.1/4
VER-030	2,590	2	34,92	1.3/8
VER-032	3,078	2	38,10	1,1/2
VER-034	3,620	2	41,27	1.5/8
VER-036	4,200	2	44,45	1.3/4
VER-038	4,830	2	47,62	1.7/8
VER-040	5,490	2	50,80	2
VER-049	6,176	2	53,98	2.1/8
VER-050	6,923	2	57,15	2.1/4
VER-042	8,580	1	63,50	2.1/2
VER-051	10,343	1	69,85	2.3/4
VER-043	12,320	1	76,20	3
VER-044	16,759	1	88,90	3.1/2
VER-045	21,873	1	101,60	4
VER-046	27,689	1	114,30	4.1/2
VER-047	34,186	1	127,00	5

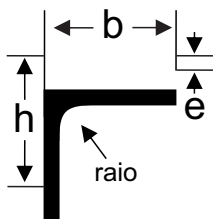

CANTONEIRAS DE ABAS IGUAIS COM RAIO

PERFIL ALCANN	PESO LINEAR (kg/m)	F.S.	mm		pol.	
			b = h	e = r	b = f	e = r
L - 140	1,660	7	50,80	6,35	2	1/4
L - 144	1,585	9	63,50	4,76	2.1/2	3/16

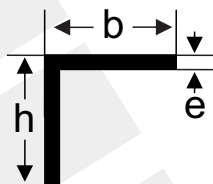

CANTONEIRAS DE ABAS IGUAIS

PERFIL ALCANN	PESO LINEAR (kg/m)	F.S.	mm		pol.	
			b = h	e	b = f	e
L-002	0,100	26	12,70	1,59	1/2	1/16
L-004	0,150	20	12,70	2,38	1/2	3/32
L-005	0,190	16	12,70	3,18	1/2	1/8
L-006	0,150	23	15,00	2,00		
L-008	0,240	15	15,88	3,18	5/8	1/8
L-405	0,130	29	15,88	1,59	5/8	1/16
L-009	0,150	29	19,05	1,59	3/4	1/16
L-010	0,230	19	19,05	2,38	3/4	3/32
L-011	0,300	15	19,05	3,18	3/4	1/8
L-249	0,273	19	22,23	2,38	7/8	3/32
L-012	0,350	15	22,23	3,18	7/8	1/8
L-013	0,210	28	25,40	1,59	1	1/16
L-014	0,410	14	25,40	3,18	1	1/8
L-015	0,590	10	25,40	4,76	1	3/16
L-018	0,515	14	31,75	3,18	1.1/4	1/8
L-019	0,750	10	31,75	4,76	1.1/4	3/16
L-020	0,575	14	34,93	3,18	1.3/8	1/8
L-022	0,620	14	38,10	3,18	1.1/2	1/8
L-023	0,910	10	38,10	4,76	1.1/2	3/16
L-024	1,197	7	38,10	6,35	1.1/2	1/4
L-336	0,670	18	50,80	2,50	2	
L-025	0,840	14	50,80	3,18	2	1/8
L-026	1,240	10	50,80	4,76	2	3/16
L-027	1,620	7	50,80	6,35	2	1/4
L-457	1,074	14	63,50	3,18	2.1/2	1/8
L-029	2,060	7	63,50	6,35	2.1/2	1/4

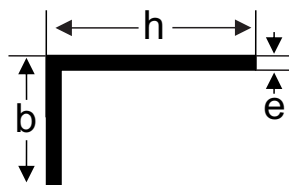

CANTONEIRAS DE ABAS DESIGUAIS

PERFIL ALCANN	PESO LINEAR (kg/m)	F.S.	mm			pol	
			h	b	e	b	h
L-093	0,300	13	25,40	12,70	3,18	1	1/2
L-094	0,350	13	25,40	19,05	3,18	1	3/4
L-442	0,180	32	30,00	19,00	1,40		
L-434	0,210	28	30,00	20,00	1,60		
L-096	0,360	13	30,10	15,10	3,18		
L-297	0,527	15	38,00	30,00	3,00		
L-099	0,466	13	38,10	19,05	3,18	1.1/2	3/4
L-100	0,521	13	38,10	25,40	3,18	1.1/2	1
L-102	0,259	22	40,00	10,00	2,00		
L-104	0,600	13	50,80	25,40	3,18	2	1
L-106	0,700	13	50,80	38,10	3,18	2	1.1/2
L-456	0,275	33	66,50	12,70	1,30		

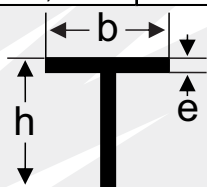

PERFIS T

PERFIL ALCANN	PESO LINEAR (kg/m)	F.S.	mm			pol	
			b	h	e	b	h
T-003	0,192	13	12,70	12,70	3,20	1/2	1/2
T-005	0,245	13	15,90	15,90	3,20	5/8	5/8
T-006	0,195	31	19,05	19,05	2,00	3/4	3/4
T-007	0,295	13	19,05	19,05	3,20	3/4	3/4
T-008	0,350	13	19,05	25,40	3,20	3/4	1
T-141	0,273	19	22,20	22,20	2,40	7/8	7/8
T-011	0,350	13	22,20	22,20	3,20	7/8	7/8
T-123	0,162	37	25,40	25,40	1,20	1	1
T-076	0,213	28	25,40	25,40	1,60	1	1
T-012	0,405	13	25,40	25,40	3,20	1	1
T-015	0,461	13	28,60	28,60	3,20	1.1/8	1.1/8
T-018	0,518	13	31,75	31,75	3,20	1.1/4	1.1/4
T-019	0,750	9	31,75	31,75	4,75	1.1/4	1.1/4
T-020	0,570	13	34,90	34,90	3,20	1.3/8	1.3/8
T-151	0,333	22	38,10	25,40	2,00	1.1/2	1
T-021	0,628	13	38,10	38,10	3,20	1.1/2	1.1/2
T-022	0,918	10	38,10	38,10	4,76	1.1/2	1.1/2
T-023	0,845	13	50,80	50,80	3,20	2	2
T-024	1,240	9	50,80	50,80	4,75	2	2
T-025	1,638	7	50,80	50,80	6,35	2	2
T-098	1,690	11	85,00	75,00	4,00		

ALUMIBEL

Comércio de Alumínio e Acessórios

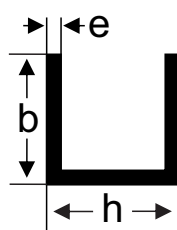

PERFIS U DE ABAS IGUAIS

PERFIL ALCANN	PESO LINEAR (kg/m)	F.S.	mm		pol	
			h=b	.	h=b	.
U-036	0,108	27	9,50	1,60	3/8	1/16
U-038	0,110	29	10,00	1,50		
U-044	0,151	27	12,70	1,60	1/2	1/16
U-045	0,215	18	12,70	2,40	1/2	
U-554	0,180	28	15,00	1,60		1/16
U-049	0,278	18	15,88	2,40	5/8	
U-509	0,192	28	15,90	1,60		1/16
U-576	0,185	29	16,00	1,50		
U-058	0,336	18	19,05	2,38	3/4	3/32
U-059	0,490	14	19,05	3,15	3/4	
U-064	0,367	18	22,20	2,40	7/8	
U-065	0,515	13	22,20	3,20	7/8	
U-245	0,459	18	25,40	2,38	1	3/32
U-070	0,630	13	25,40	3,20	1	
U-072	0,680	14	30,00	3,00		
U-076	0,761	14	31,75	3,17	1.1/4	1/8
U-083	0,933	13	38,10	3,20	1.1/2	

ALUMIBEL

PERFIS U

Comércio de Alumínio e Acessórios

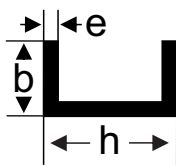

PERFIS U DE ABAS DESIGUAIS

PERFIL ALCANN	PESO LINEAR (kg/m)	F.S.	mm			pol.		
			h	b	.	h	b	.
U-583	0,170	30	7,00	19,00	1,50			
U-034	0,081	43	8,00	12,00	1,00			
U-037	0,129	27	9,50	12,70	1,60		1/2	1/16
U-042	0,120	27	12,70	9,50	1,60	1/2		1/16
U-047	0,173	18	15,88	7,93	2,38	5/8	5/16	3/32
U-048	0,194	18	15,88	9,52	2,40	5/8	3/8	
U-054	0,216	18	19,05	9,52	2,40	3/4	3/8	
U-056	0,257	18	19,05	12,70	2,40	3/4	1/2	3/32
U-060	0,505	18	19,05	31,75	2,40	3/4	1.1/4	
U-061	0,190	29	20,00	15,00	1,50			
U-415	0,200	30	23,00	15,00	1,50			
U-068	0,330	14	25,40	9,50	3,15	1	3/8	
U-069	0,380	14	25,40	12,70	3,15	1	1/2	
U-071	0,440	14	30,00	15,00	3,00			
U-073	0,380	14	31,75	9,52	3,17	1.1/4	3/8	1/8
U-074	0,435	14	31,75	12,70	3,17	1.1/4	1/2	1/8
U-075	0,490	14	31,75	15,90	3,15	1.1/4	5/8	
U-512	0,300	29	37,00	20,00	1,50			
U-080	0,260	27	38,10	12,70	1,60	1.1/2	1/2	1/16
U-082	0,378	18	38,10	12,70	2,38	1.1/2	1/2	3/32
U-086	0,525	18	47,62	19,05	2,40	1.7/8	3/4	
U-087	0,810	14	50,80	25,40	3,15	2	1	
U-088	1,180	9	50,80	25,40	4,75	2	1	3/16
U-544	0,410	27	60,00	19,00	1,60			1/16
U-091	1,030	13	76,20	25,40	3,20	3	1	
U-093	1,680	14	101,60	50,80	3,15	4	2	
U-582	2,986	7	110,00	38,10	6,35		1.1/2	1/4

ALUMIBEL

Comércio de Alumínio e Acessórios

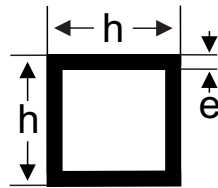

TUBOS QUADRADOS

PERFIL ALCANN	PESO LINEAR (kg/m)	F.S.	mm		pol
			h	.	h
TUB-4001	0,200	26	12,70	1,65	1/2
TUB-4002	0,233	29	15,90	1,50	5/8
TUB-4003	0,284	29	19,05	1,50	3/4
TUB-4004	0,395	22	19,05	2,00	3/4
TUB-4008	0,386	29	25,40	1,50	1
TUB-4009	0,525	21	25,40	2,05	1
TUB-4010	0,595	18	25,40	2,40	1
TUB-4011	0,491	29	31,75	1,50	1.1/4
TUB-4014	0,591	29	38,10	1,50	1.1/2
TUB-4015	0,780	22	38,10	2,00	1.1/2
TUB-4020	1,055	22	50,80	2,00	2
TUB-4029	1,795	12	50,80	3,50	2
TUB-4023	1,970	14	63,50	3,05	2.1/2
TUB-4025	3,995	11	101,60	3,80	4

ALUMIBEL

Comércio de Alumínio e Acessórios

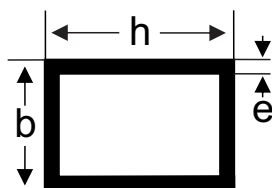

TUBOS RETANGULARES

PERFIL ALCANN	PESO LINEAR (kg/m)	F.S.	mm			pol.	
			b	h	.	b	h
TUB-4501	0,310	26	12,70	25,40	1,65	1/2	1
TUB-4536	0,521	27	12,70	50,80	1,60	1/2	2
TUB-4551	0,382	29	20,00	30,00	1,50		
TUB-4509	0,497	22	20,00	30,00	2,00		
TUB-4544	0,535	27	20,00	45,00	1,60		
TUB-4541	0,875	21	21,00	63,50	2,00		2.1/2
TUB-4550	0,417	29	22,22	32,00	1,50	7/8	
TUB-4546	0,800	25	25,00	65,00	1,70		
TUB-4538	1,158	20	25,00	77,00	2,20		
TUB-4545	0,645	21	25,40	38,10	2,00	1	1.1/2
TUB-4504	0,810	22	25,40	50,80	2,00	1	2
TUB-4512	1,123	21	32,00	76,00	2,00		
TUB-4513	0,918	22	38,10	50,80	2,00	1.1/2	2
TUB-4543	0,875	25	38,10	60,30	1,70	1.2/2	2.3/8
TUB-4517	1,190	22	38,10	76,20	2,00	1.1/2	3
TUB-4518	1,760	14	38,10	76,20	3,05	1.1/2	3
TUB-4537	1,750	18	38,10	101,60	2,40	1.1/2	4
TUB-4520	3,181	13	38,10	152,40	3,20	1.1/2	6
TUB-4521	1,253	22	40,00	80,00	2,00		
TUB-4526	4,150	11	50,00	150,00	4,00		
TUB-4530	2,385	14	50,80	101,60	3,05	2	4
TUB-4531	3,630	9	50,80	101,60	4,75	2	4
TUB-4542	2,710	17	80,00	125,00	2,50		
TUB-4559	3,206	14	50,80	152,40	3,00	2	6

ALUMIBEL

TUBOS REDONDOS

Comércio de Alumínio e Acessórios

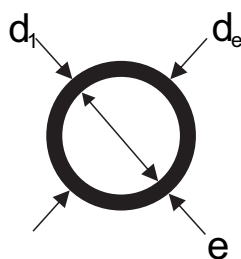

TUBOS REDONDOS

PERFIL ALCANN	PESO LINEAR (kg/m)	F.S.	mm			pol.		
			de	d1	.	de	d1	.
TUB-003	0,108	27	9,53	6,35	1,59	3/8	1/4	1/16
TUB-009	0,120	34	12,70	10,22	1,24	1/2		
TUB-010	0,150	27	12,70	9,52	1,59	1/2	3/8	1/16
TUB-011	0,180	21	12,70	8,70	2,00	1/2		
TUB-012	0,256	14	12,70	6,34	3,18	1/2	1/4	1/8
TUB-018	0,154	35	15,88	13,40	1,24	5/8		
TUB-019	0,192	24	15,88	12,70	1,59	5/8	1/2	1/16
TUB-171	0,240	21	15,88	11,88	2,00	5/8		
TUB-027	0,184	35	19,05	16,57	1,24	3/4		
TUB-028	0,234	27	19,05	15,87	1,59	3/4	5/8	1/16
TUB-038	0,278	27	22,23	19,05	1,59	7/8	3/4	1/16
TUB-039	0,343	22	22,23	18,23	2,00	7/8		
TUB-046	0,320	27	25,40	22,22	1,59	1	7/8	1/16
TUB-222	0,398	21	25,40	21,40	2,00	1		
TUB-047	0,464	18	25,40	20,64	2,38	1	13/16	3/32
TUB-048	0,600	14	25,40	19,04	3,18	1	3/4	1/8
TUB-053	0,364	27	28,58	25,40	1,59	1.1/8	1	1/16
TUB-054	0,324	33	30,50	27,90	1,30	1.1/4		
TUB-058	0,405	27	31,75	28,57	1,59	1.1/4	1.1/8	1/16
TUB-059	0,505	22	31,75	27,75	2,00	1.1/4		
TUB-060	0,595	18	31,75	26,99	2,38	1.1/4	1.1/16	3/32
TUB-061	0,770	14	31,75	25,39	3,18	1.1/4	1	1/8
TUB-069	0,467	28	38,10	35,10	1,50	1.1/2		
TUB-070	0,942	13	38,10	31,74	3,18	1.1/2	1.1/4	1/8
TUB-192	0,500	30	43,00	40,20	1,40			
TUB-082	0,721	22	44,45	40,45	2,00	1.3/4		
TUB-091	0,826	21	50,80	46,80	2,00	2		
TUB-092	1,285	13	50,80	44,44	3,18	2	1.3/4	1/8
TUB-206	1,545	14	63,50	57,50	3,00	2.1/2		
TUB-167	1,870	14	76,20	70,20	3,00	3		
TUB139	2,880	10	76,20	66,68	4,76	3	2.5/8	3/16
TUB-141	1,836	18	95,25	90,49	2,38	3.3/4	3.9/16	3/32

ALUMIBEL

Comércio de Alumínio e Acessórios

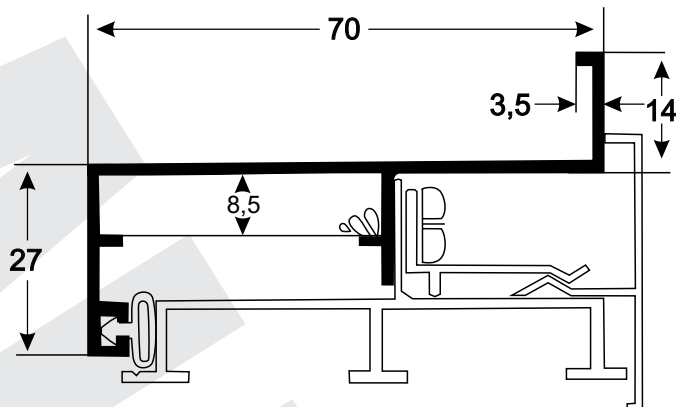

Z-114
0,564 kg/m

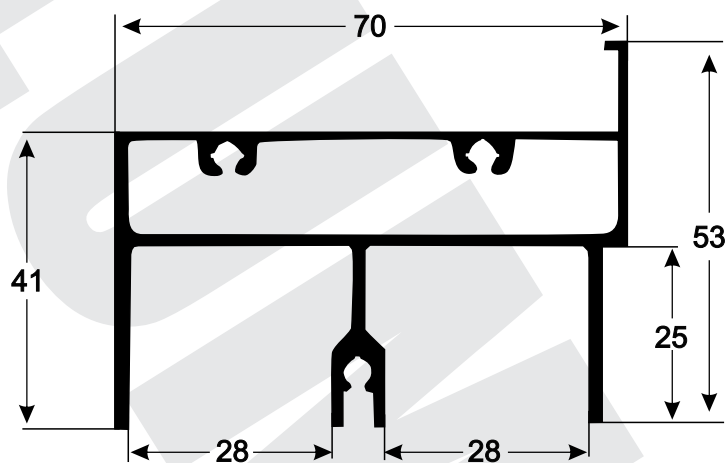

P-157
1,355 kg/m

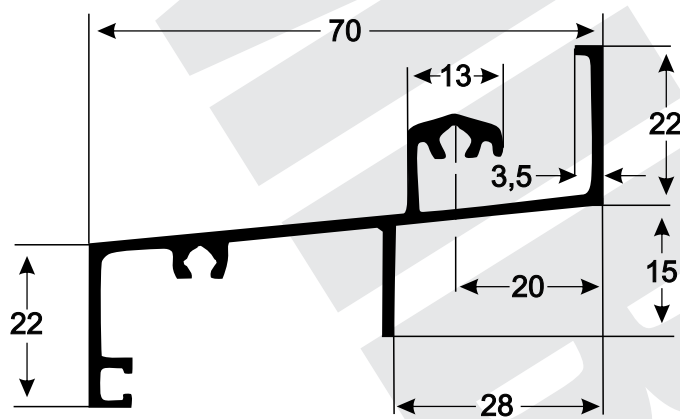

Z-170
0,796 kg/m

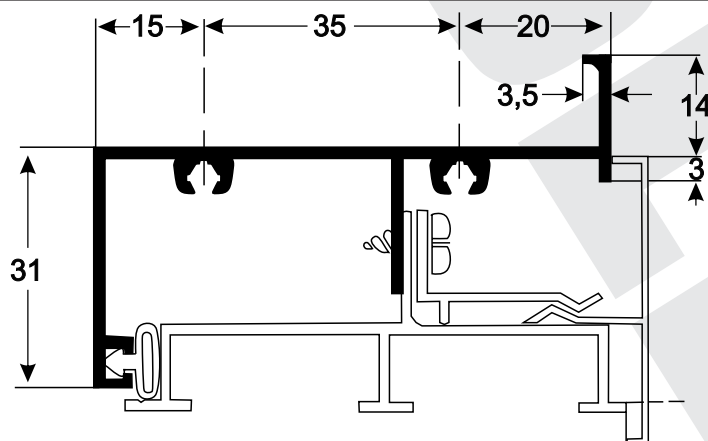

Z-115
0,634 kg/m

ALUMIBEL

Comércio de Alumínio e Acessórios

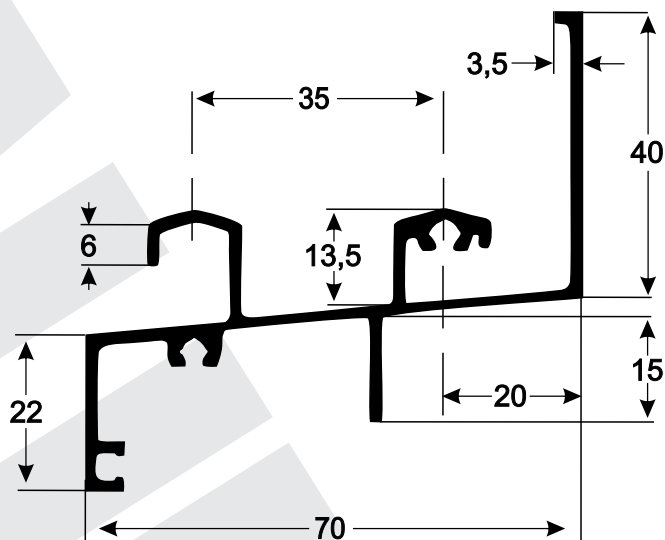

Z-171
1,016 kg/m

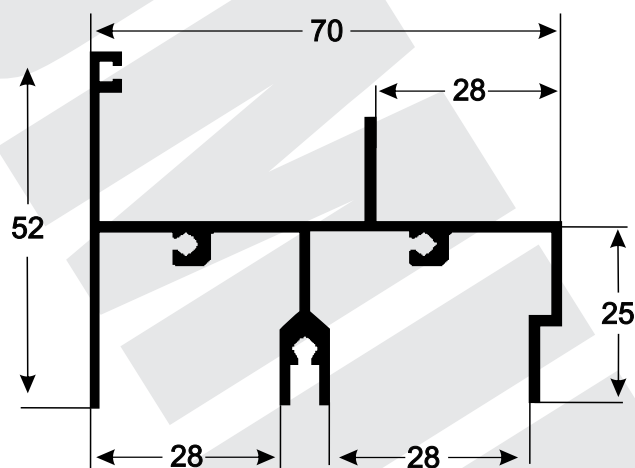

E-186
1,043 kg/m

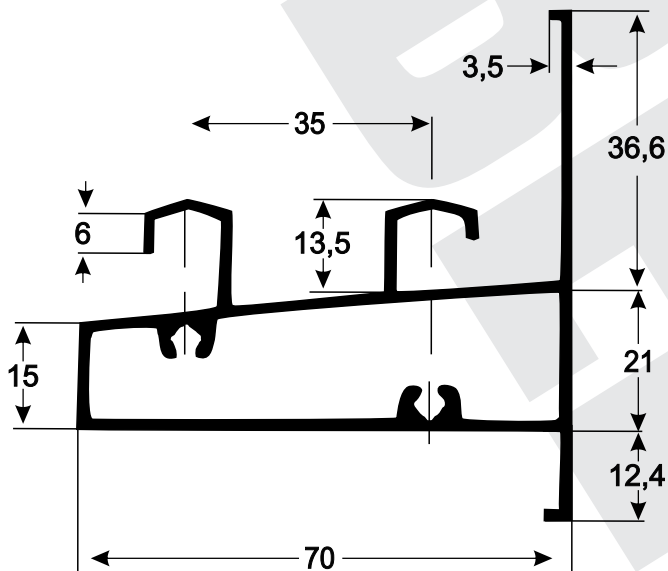

P-254
1,323 kg/m

ALUMIBEL

Comércio de Alumínio e Acessórios

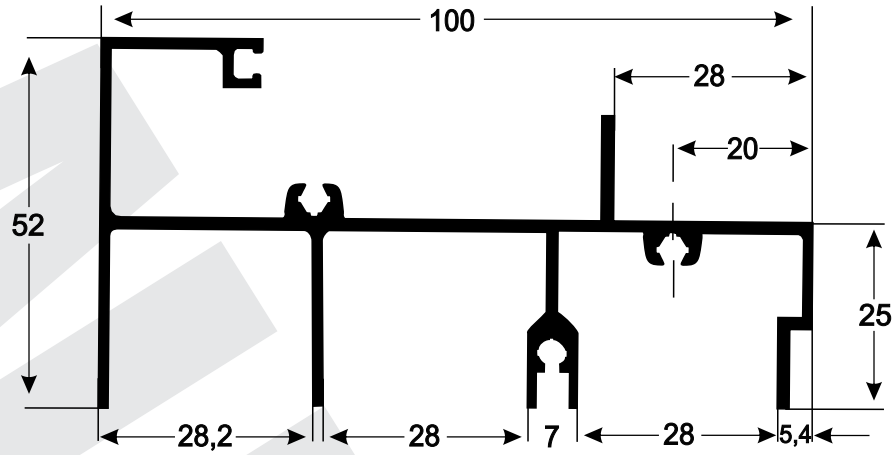

E-293
1,504 kg/m

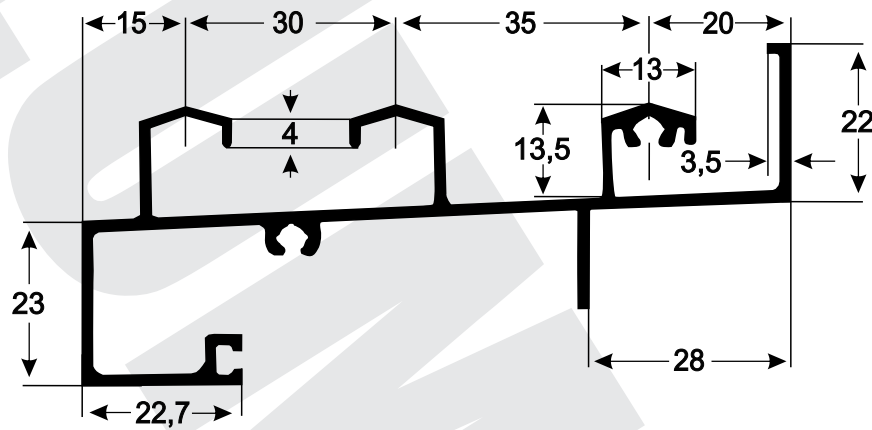

E-276
1,274 kg/m

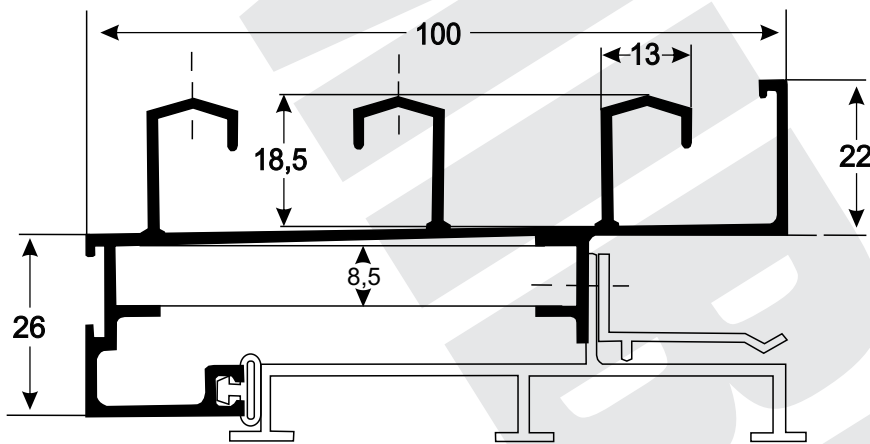

Z-173
1,355 kg/m

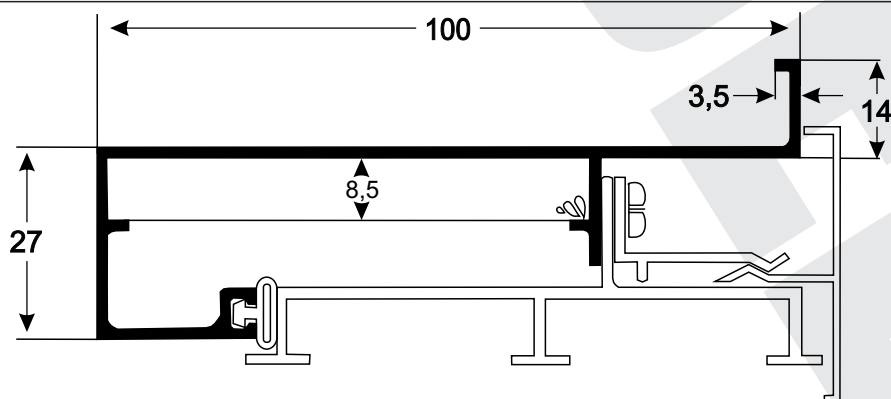

Z-192
0,835 kg/m

ALUMIBEL

Comércio de Alumínio e Acessórios

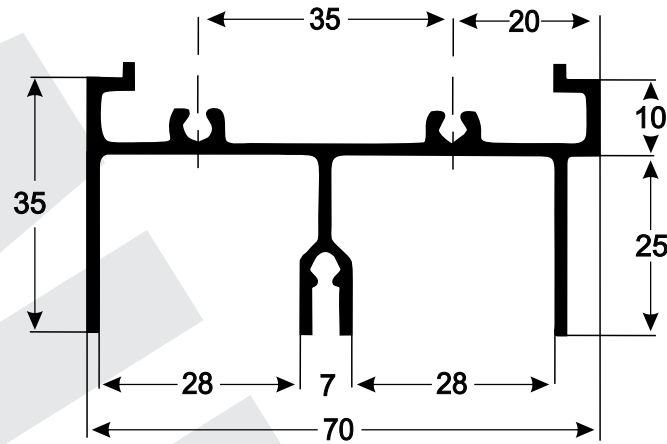

E-290
0,892 kg/m

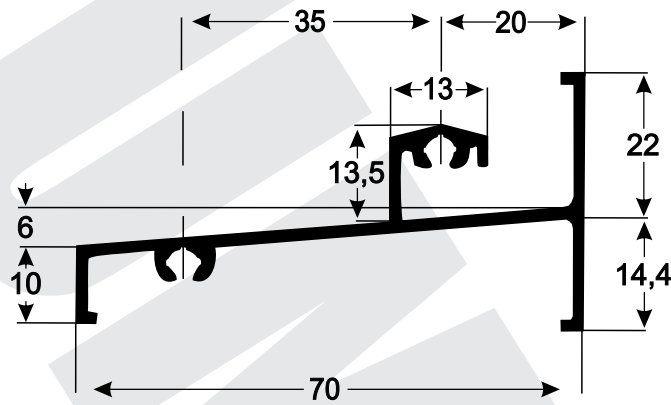

Z-174
0,726 kg/m

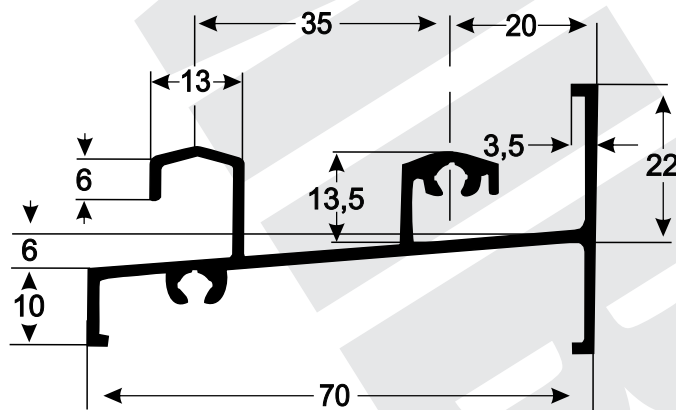

Z-176
0,854 kg/m

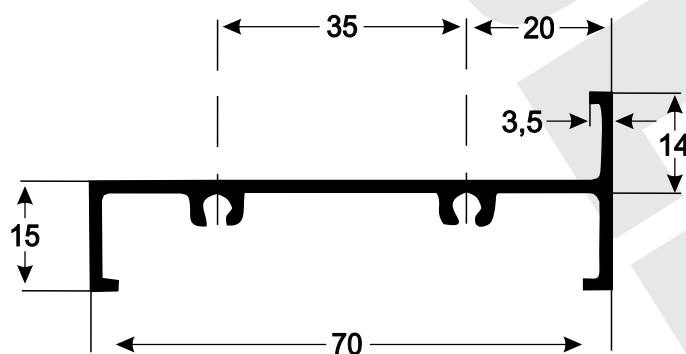

Z-175
0,569 kg/m

ALUMIBEL

Comércio de Alumínio e Acessórios

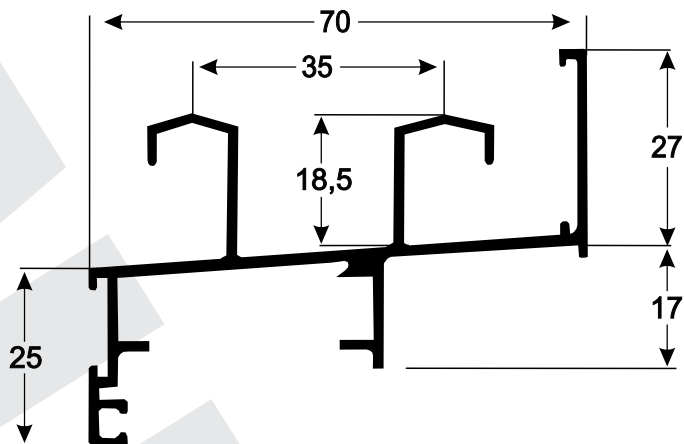

Z-172
0,989 kg/m

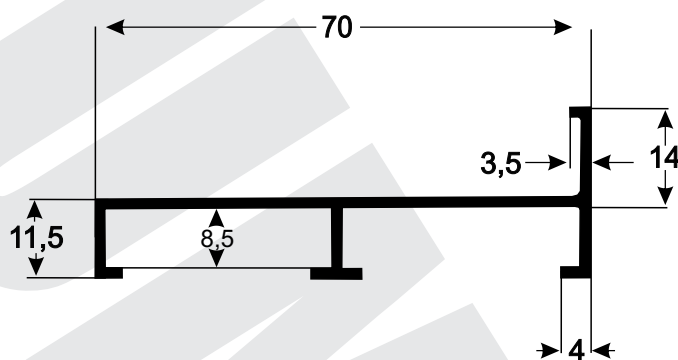

E-277
0,509 kg/m

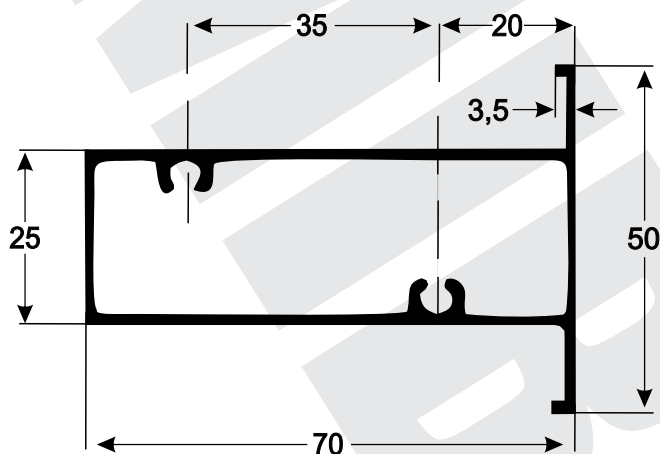

P-274
0,976 kg/m

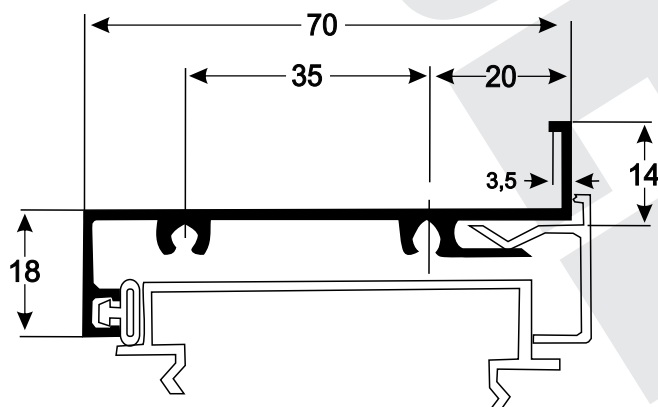

Z-177
0,542 kg/m

ALUMIBEL

Comércio de Alumínio e Acessórios

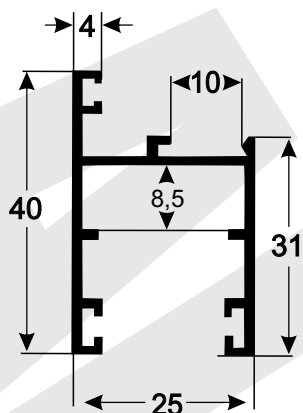

Y-195
0,480 kg/m

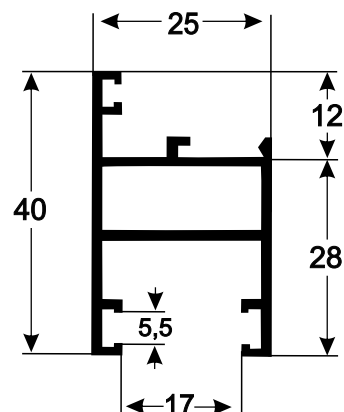

A-047
0,560 kg/m

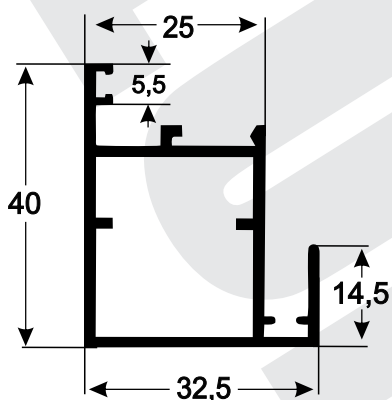

P-151
0,610 kg/m

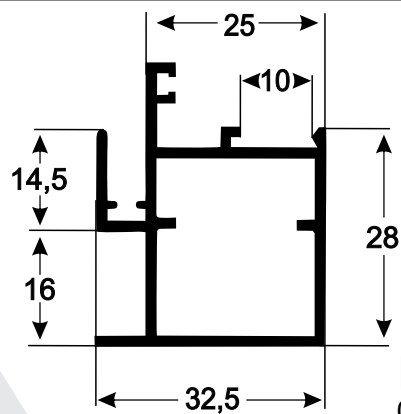

P-152
0,660 kg/m

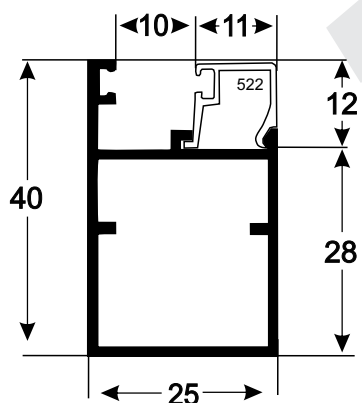

P-140
0,520 kg/m

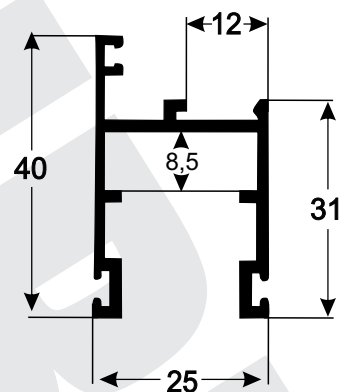

Y-196
0,485 kg/m

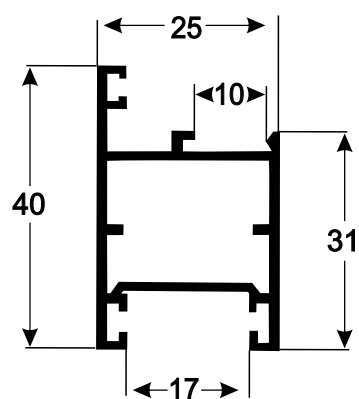

A-049
0,570 kg/m

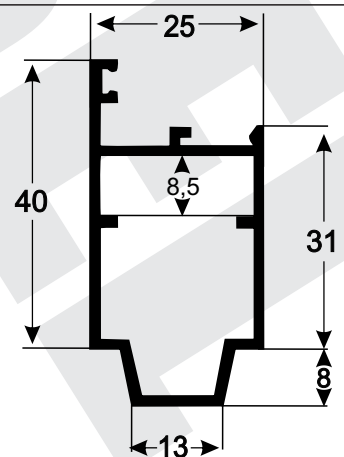

P-143
0,570 kg/m

ALUMIBEL

Comércio de Alumínio e Acessórios

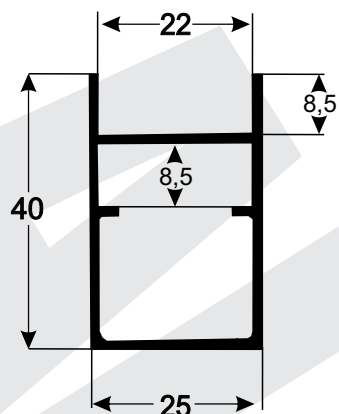

A-055
0,525 kg/m

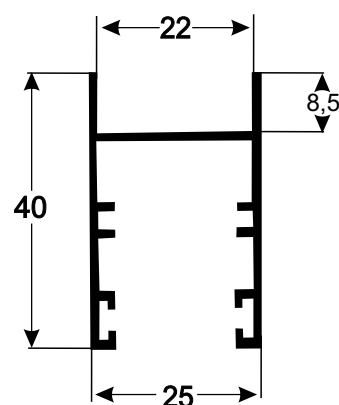

I-122
0,510 kg/m

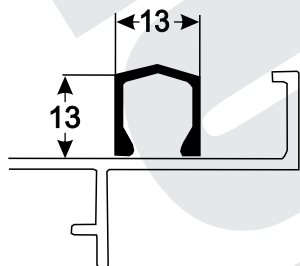

U-681
0,131 kg/m

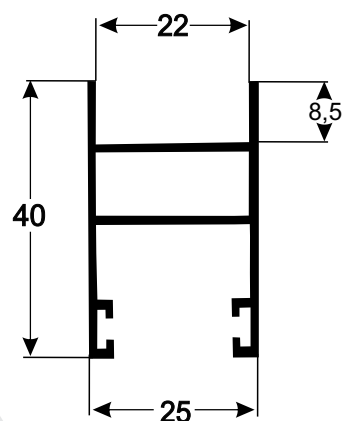

A-097
0,558 kg/m

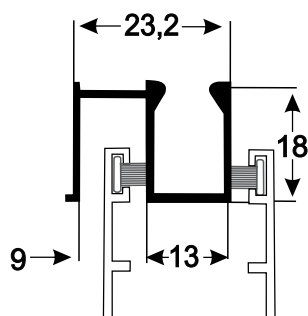

Z-074
0,260 kg/m

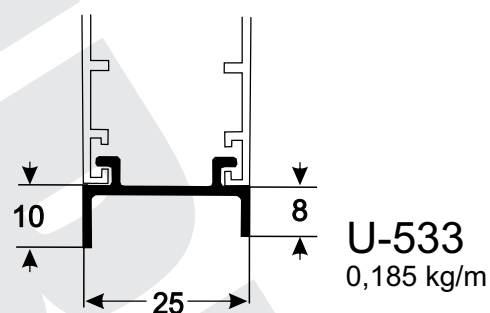

U-533
0,185 kg/m

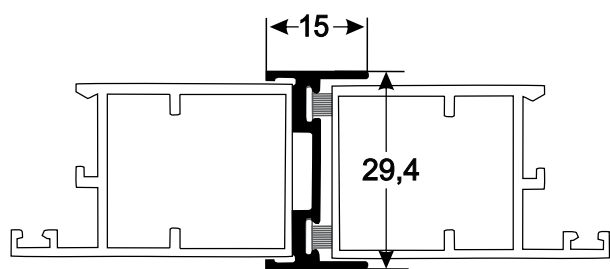

I-105
0,263 kg/m

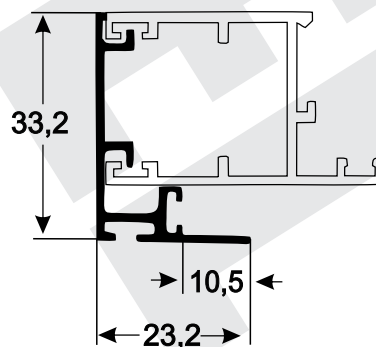

L-498
0,318 kg/m

ALUMIBEL

Comércio de Alumínio e Acessórios

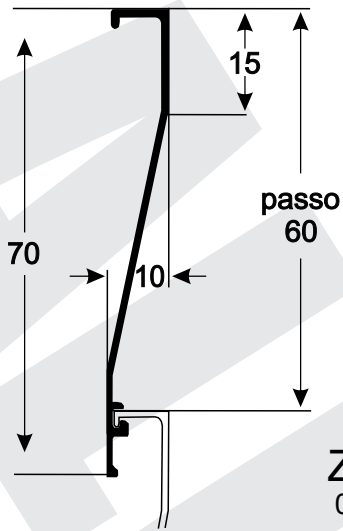

Z-163
0,257 kg/m

4,540 kg/m²

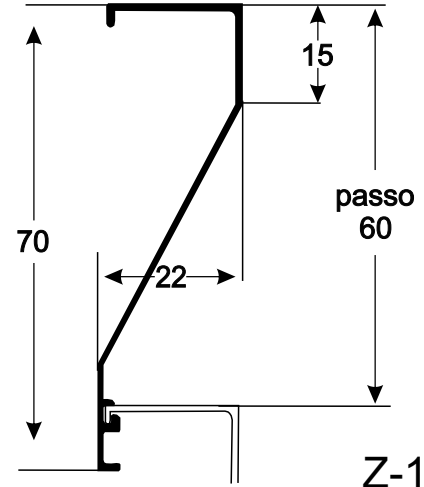

Z-148
0,342 kg/m

5,815 kg/m²

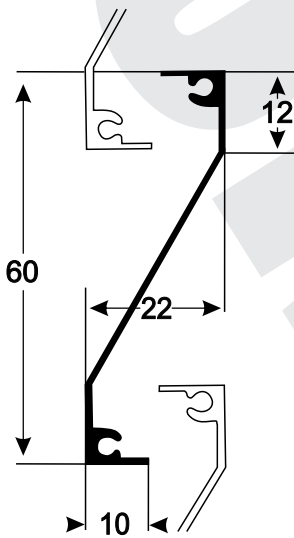

Z-073
0,322 kg/m

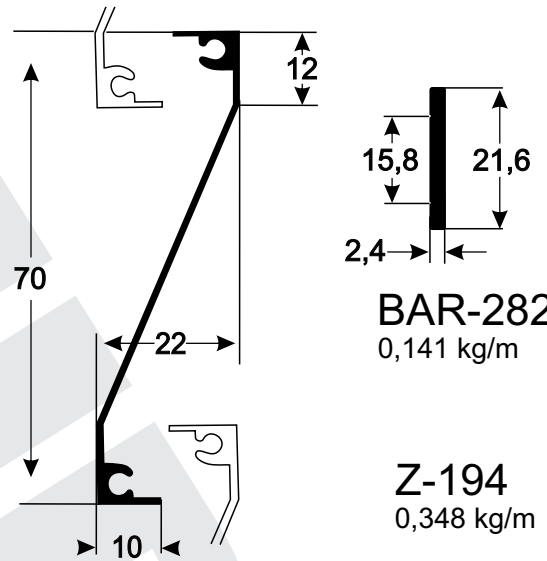

BAR-282
0,141 kg/m

Z-194
0,348 kg/m

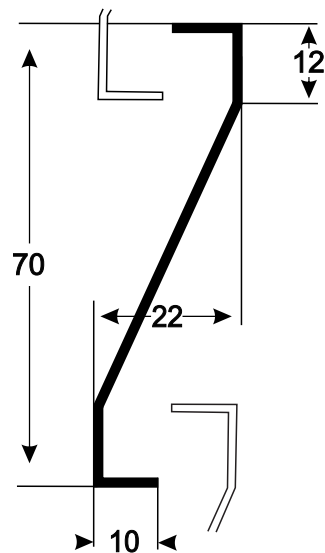

Z-098
0,328 kg/m



Z-203
0,315 kg/m

ALUMIBEL

Comércio de Alumínio e Acessórios

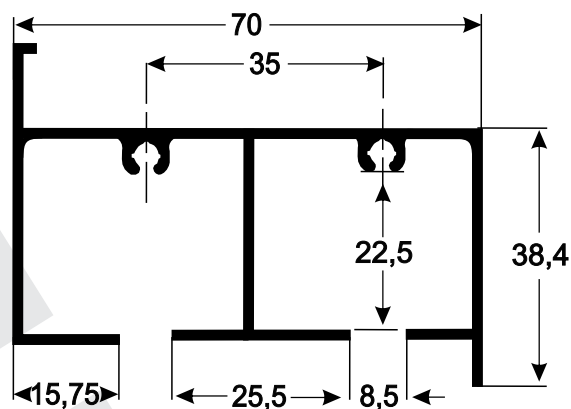

E-323
1,339 kg/m

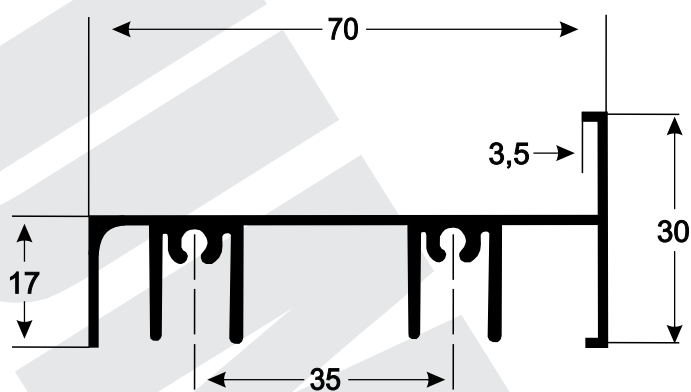

E-221
0,896 kg/m

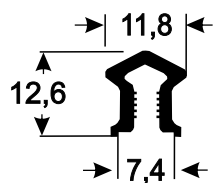

U-873
0,133 kg/m

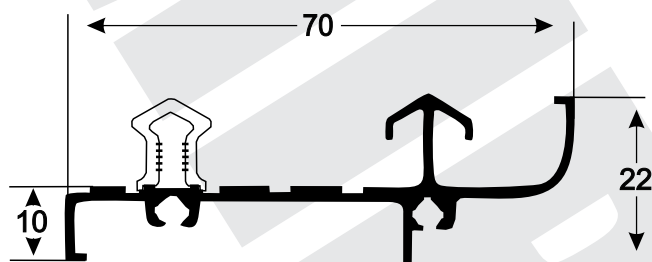

Z-221
0,664 kg/m

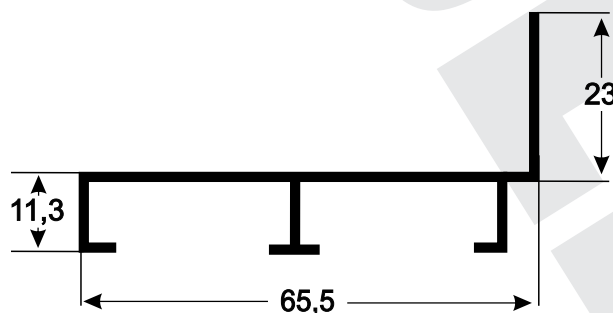

Y-474
0,494 kg/m

ALUMIBEL

Comércio de Alumínio e Acessórios

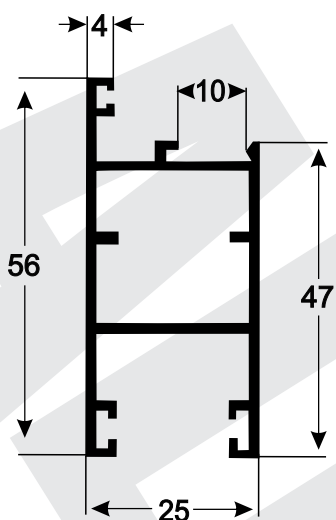

A-048
0,710 kg/m

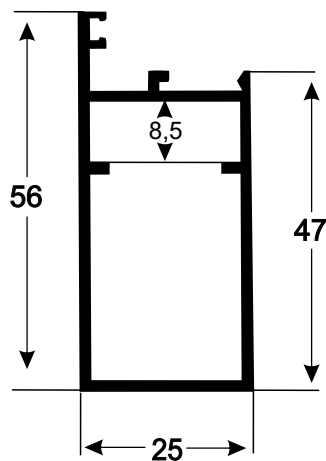

P-318
0,653 kg/m

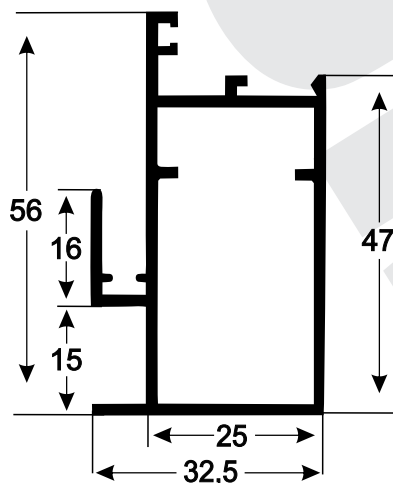

P-371
0,775 kg/m

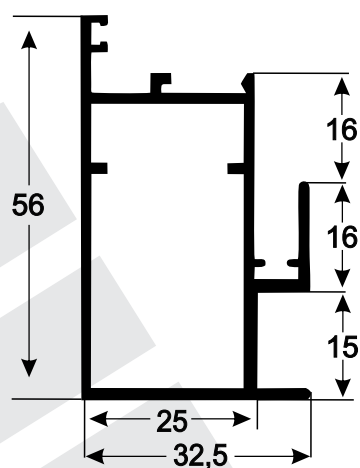

P-370
0,775 kg/m

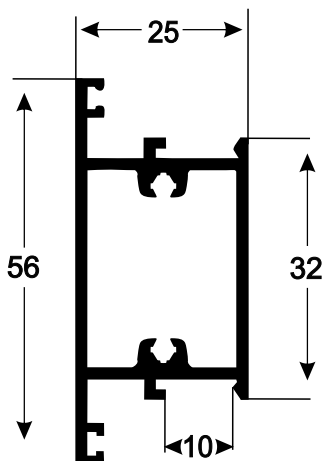

P-319
0,743 kg/m

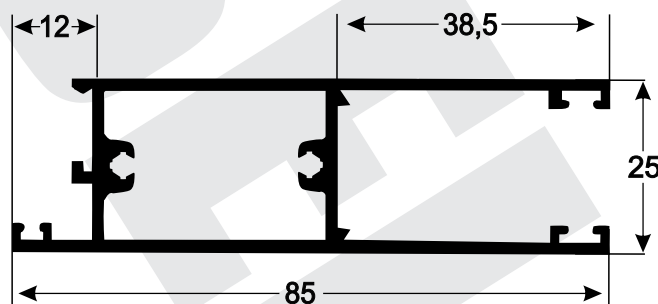

A-139
1,033 kg/m

ALUMIBEL

Comércio de Alumínio e Acessórios

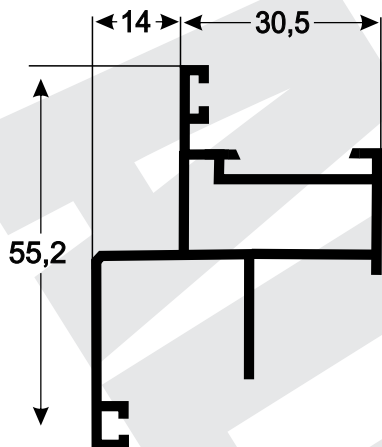

P-411
0,757 kg/m

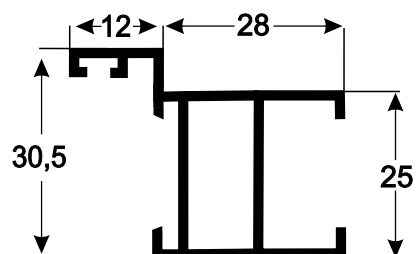

P-412
0,558 kg/m

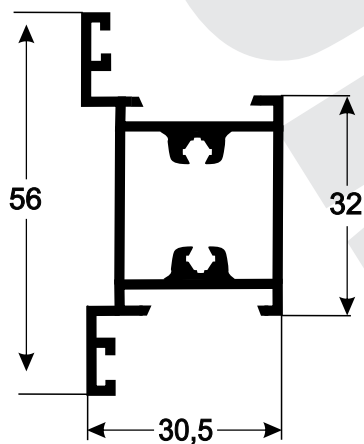

P-413
0,813 kg/m

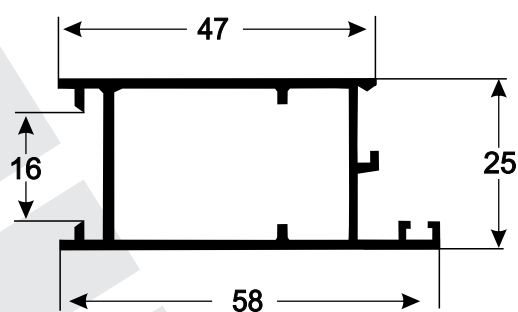

P-414
0,699 kg/m

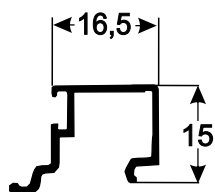

U-874
0,163 kg/m

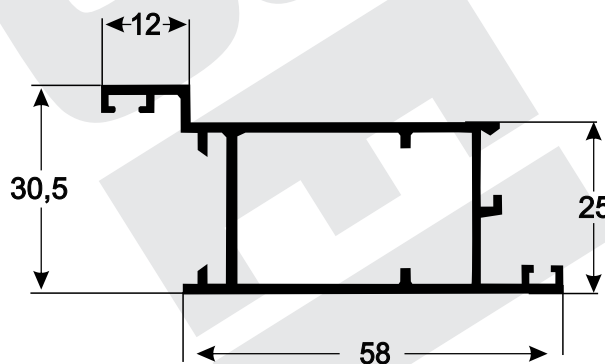

P-415
0,797 kg/m

ALUMIBEL

Comércio de Alumínio e Acessórios

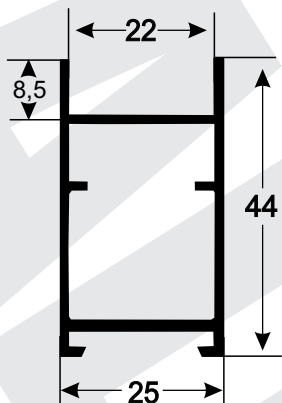

A-140
0,593 kg/m

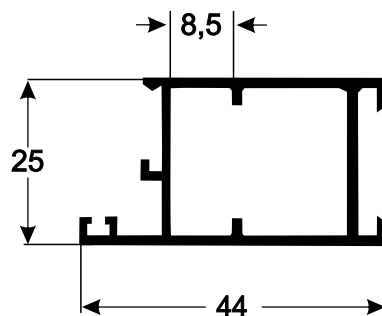

P-416
0,591 kg/m

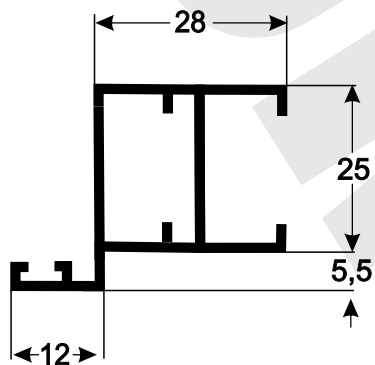

Y-476
0,464 kg/m

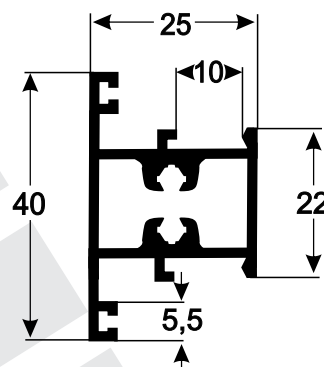

P-153
0,604 kg/m

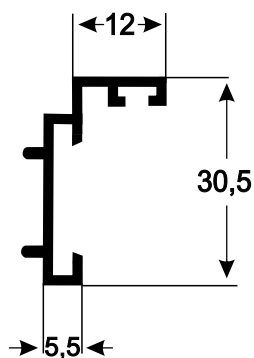

L-592
0,277 kg/m

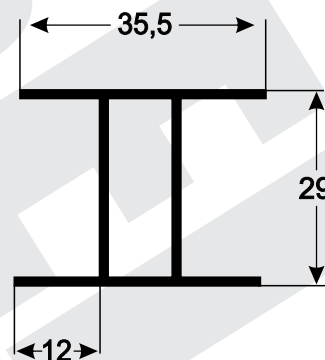

A-034
0,500 kg/m

ALUMIBEL

Comércio de Alumínio e Acessórios

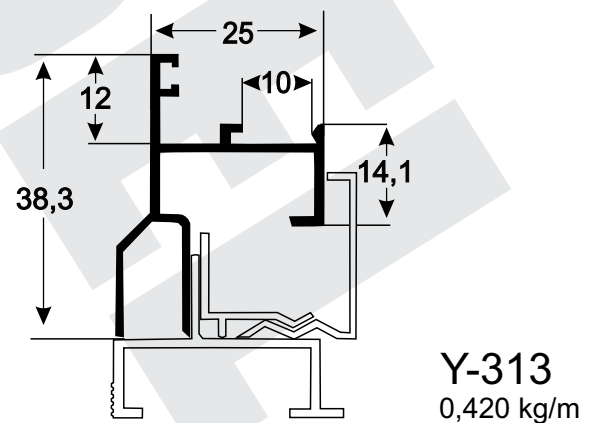
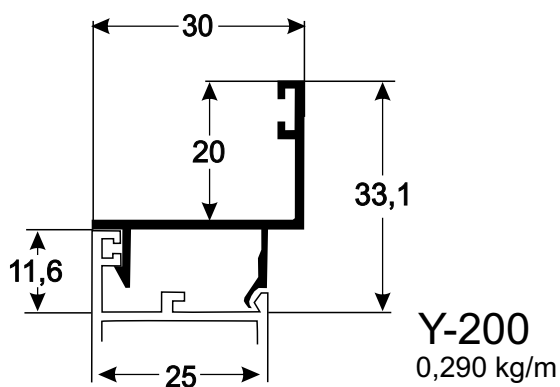
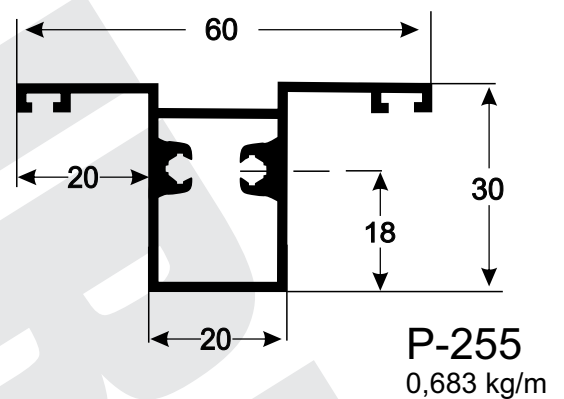
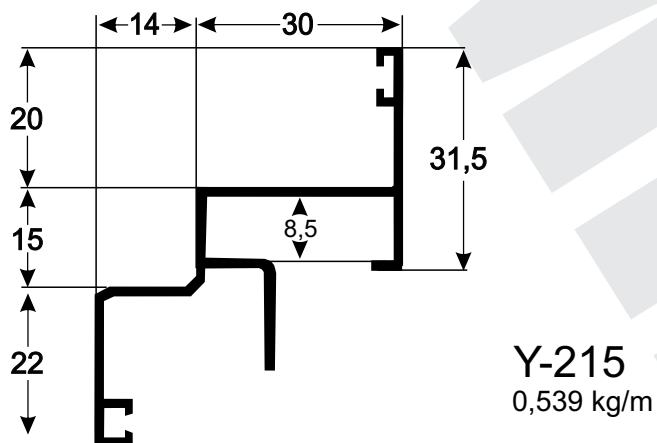
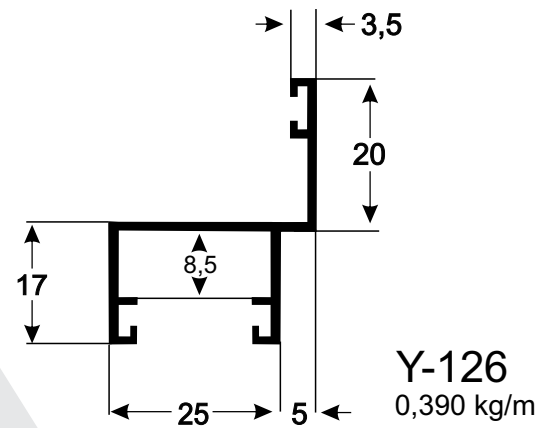
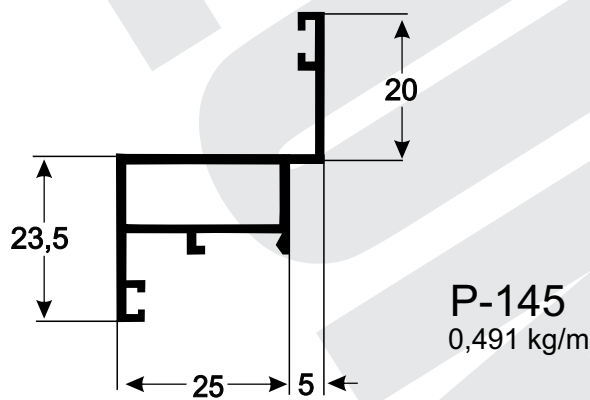
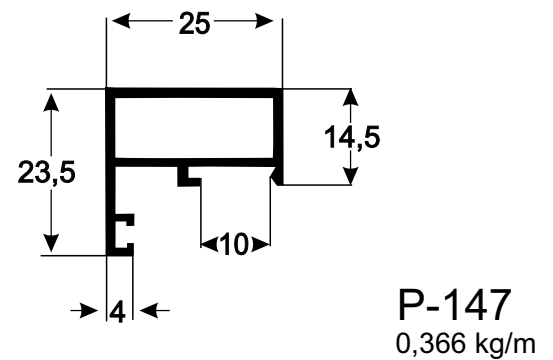
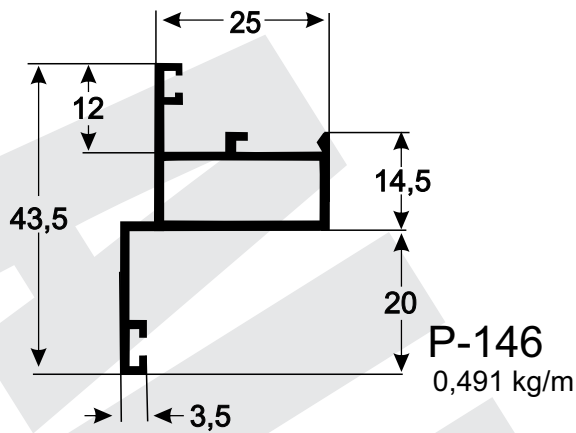

ALUMIBEL

Comércio de Alumínio e Acessórios

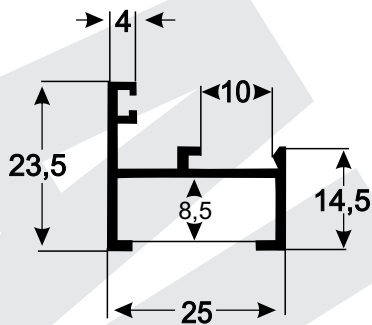

Y-197
0,298 kg/m

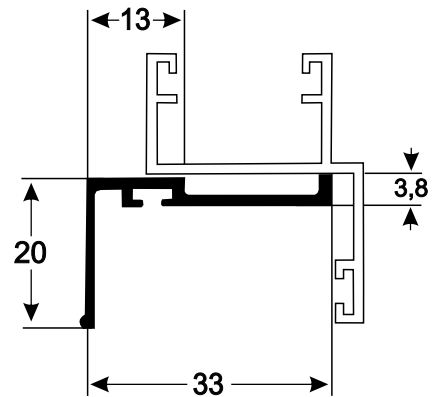

L-387
0,220 kg/m

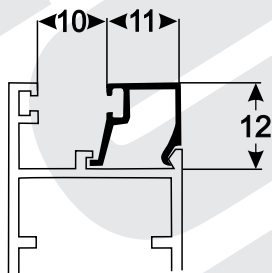

U-522
0,100 kg/m

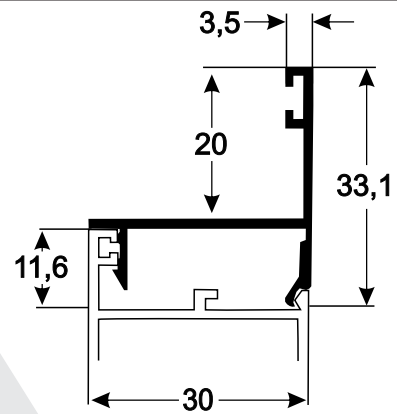

Y-201
0,290 kg/m

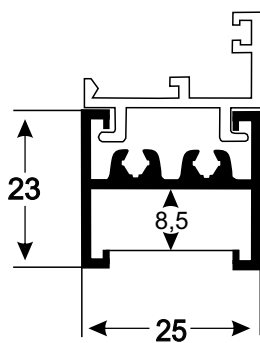

I-117
0,420 kg/m

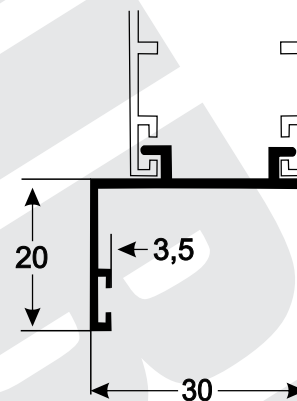

L-383
0,265 kg/m

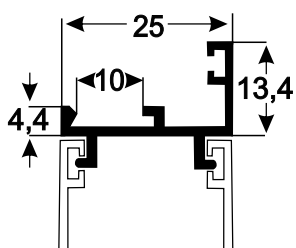

L-418
0,230 kg/m

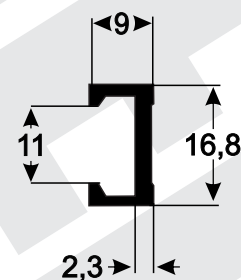

U-683
0,154 kg/m

ALUMIBEL

Comércio de Alumínio e Acessórios

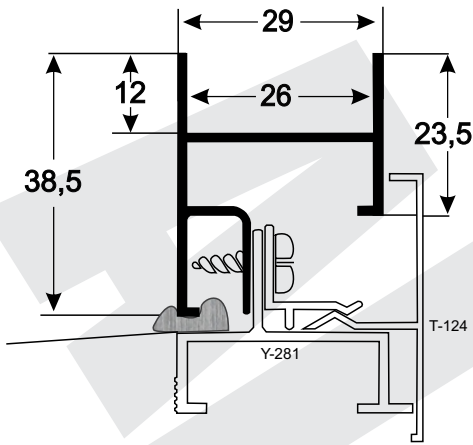

Y-283
0,470 kg/m

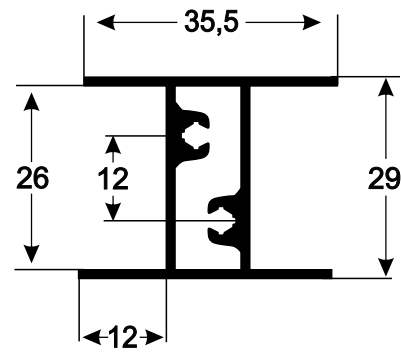

A-084
0,580 kg/m

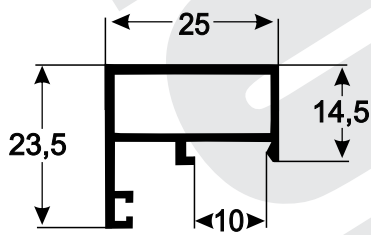

P-147
0,366 kg/m

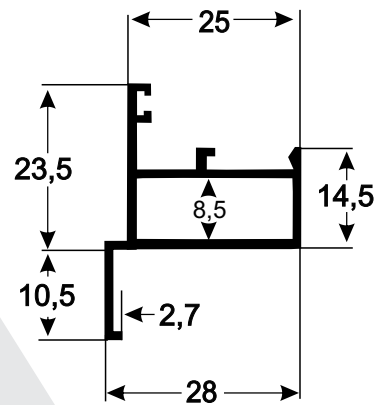

P-167
0,425 kg/m

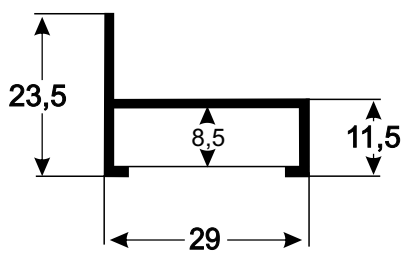

Y-120
0,260 kg/m

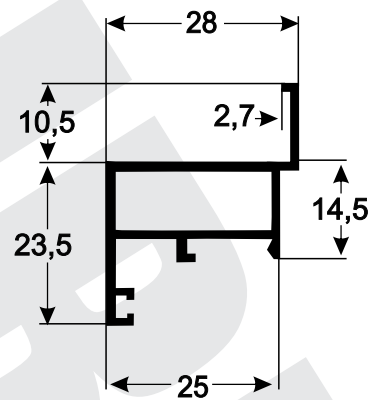

P-166
0,425 kg/m

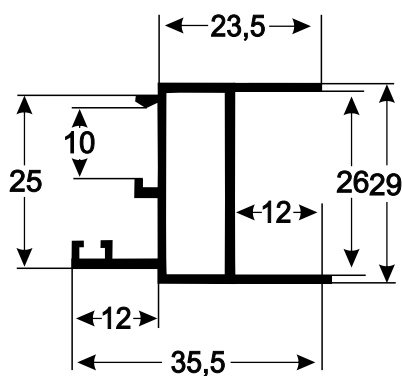

A-053
0,480 kg/m

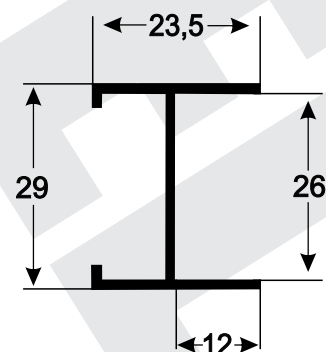

I-090
0,300 kg/m

ALUMIBEL

Comércio de Alumínio e Acessórios

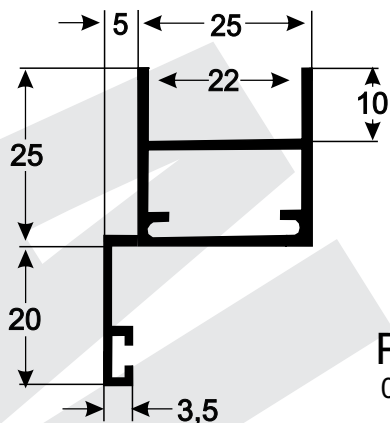

P-155
0,570 kg/m

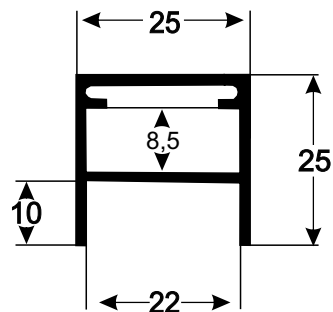

A-056
0,406 kg/m

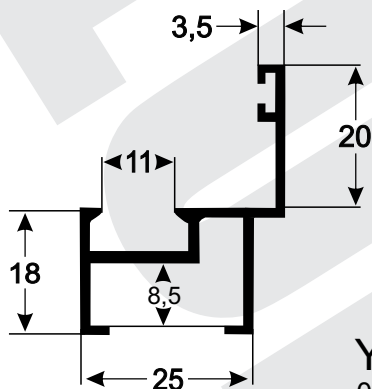

Y-204
0,380 kg/m

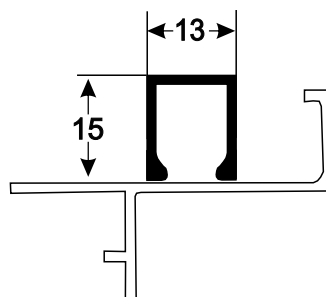

U-425
0,145 kg/m

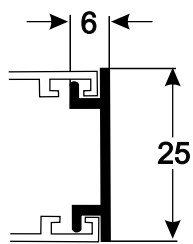

U-421
0,152 kg/m

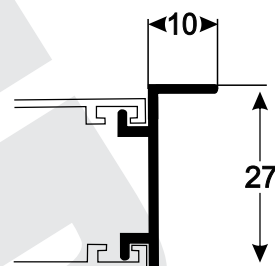

L-340
0,170 kg/m

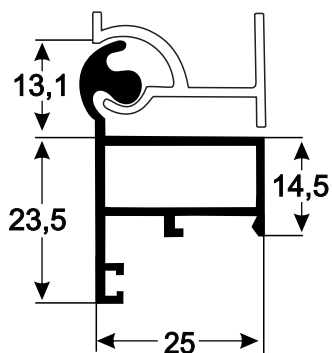

P-161
0,495 kg/m

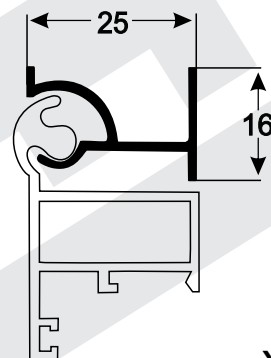

Y-227
0,260 kg/m

ALUMIBEL

Comércio de Alumínio e Acessórios

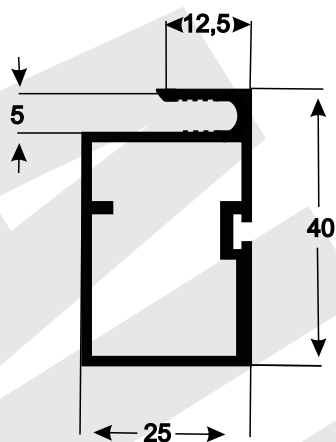

P-227
0,580 kg/m

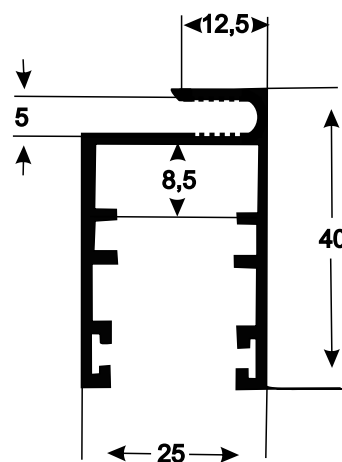

Y-312
0,550 kg/m

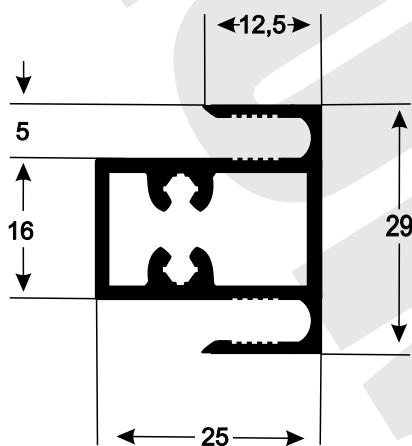

P-256
0,569 kg/m

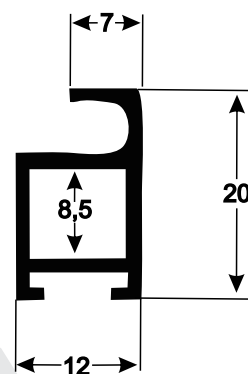

A-058
0,215 kg/m

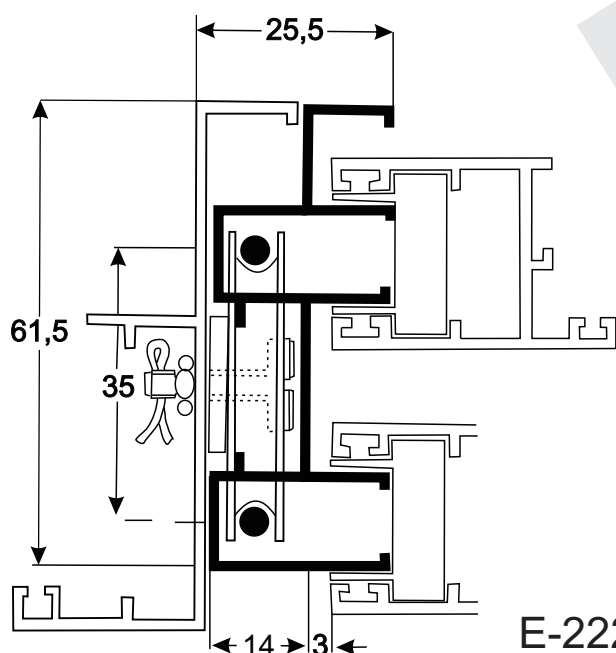

E-222
0,745 kg/m

ALUMIBEL

Comércio de Alumínio e Acessórios

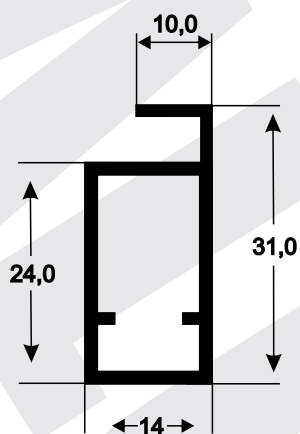

P227A
0,295 kg/m

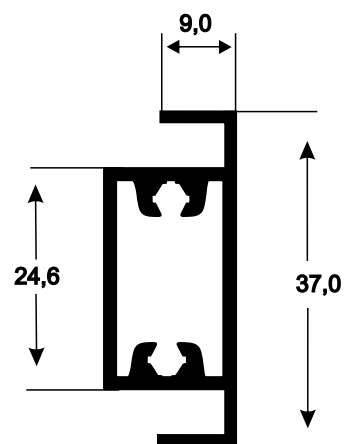

P256A
0,377 kg/m

ALUMIBEL

Comércio de Alumínio e Acessórios

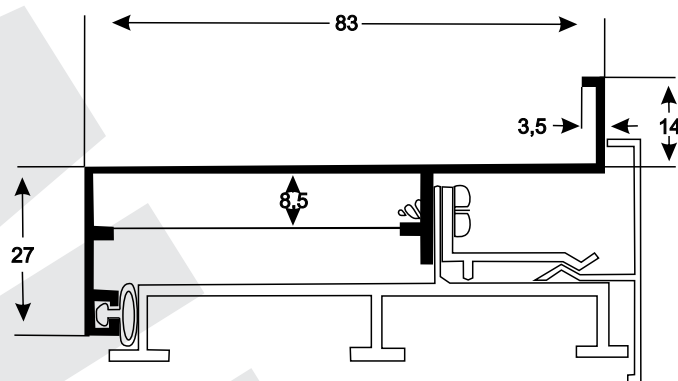

Z-118
0,665 kg/m

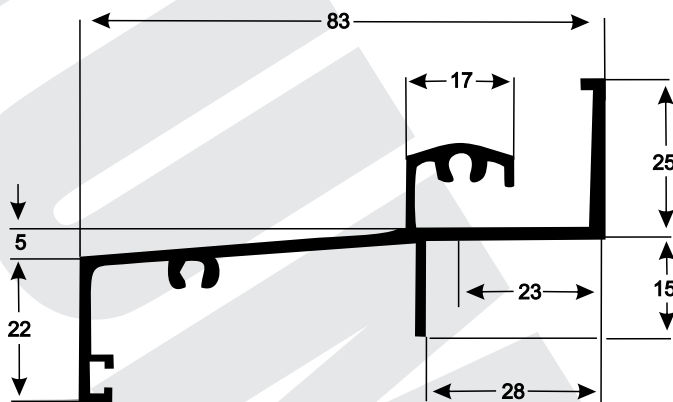

Z-167
0,840 kg/m

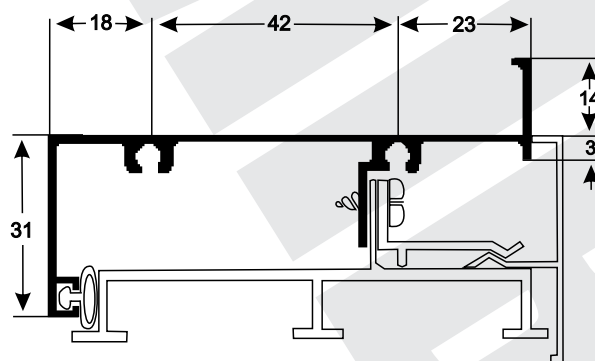

Z-179
0,740 kg/m

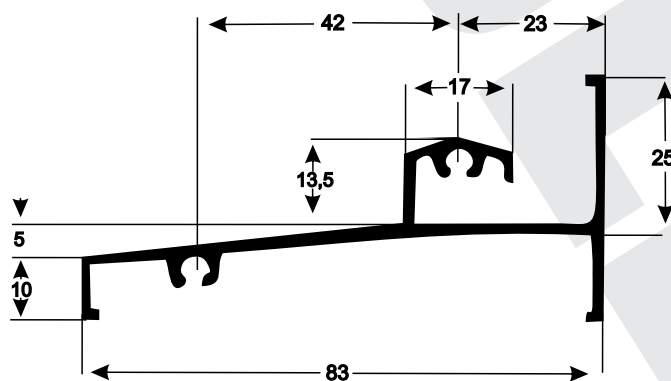

Z-180
0,310 kg/m

ALUMIBEL

Comércio de Alumínio e Acessórios

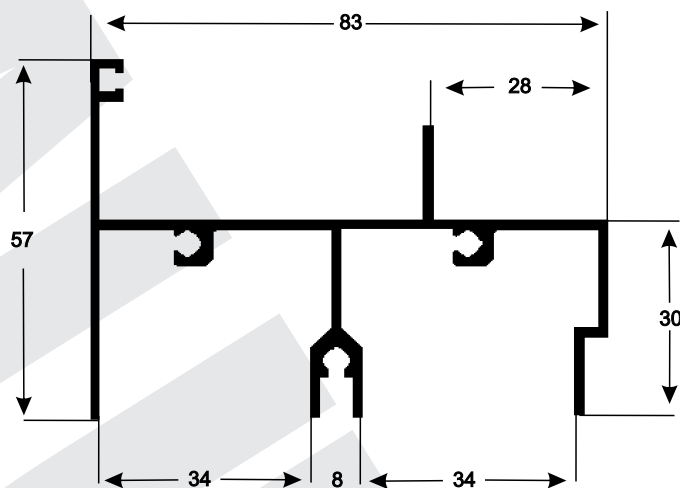

E-294
1,220 kg/m

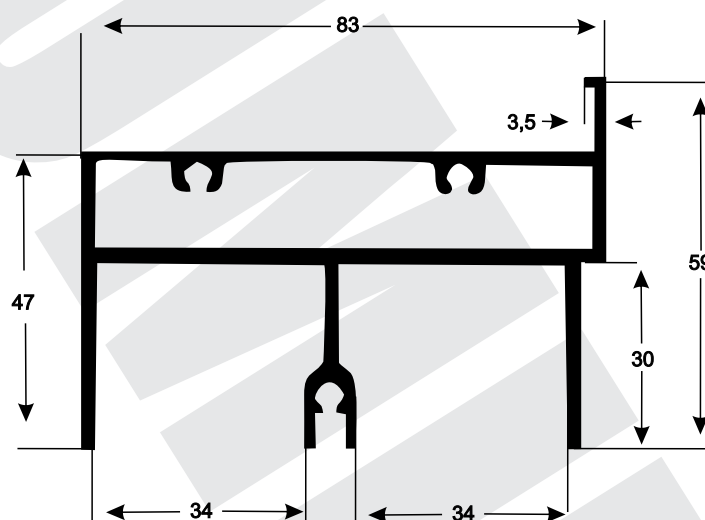

P-287
1,564 kg/m

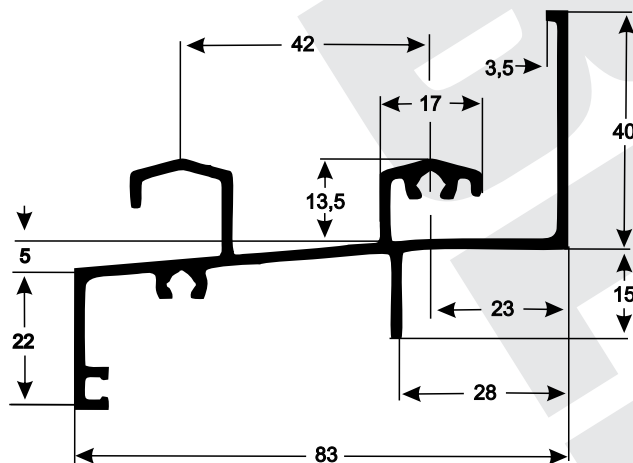

Z-178
1,065 kg/m

ALUMIBEL

Comércio de Alumínio e Acessórios

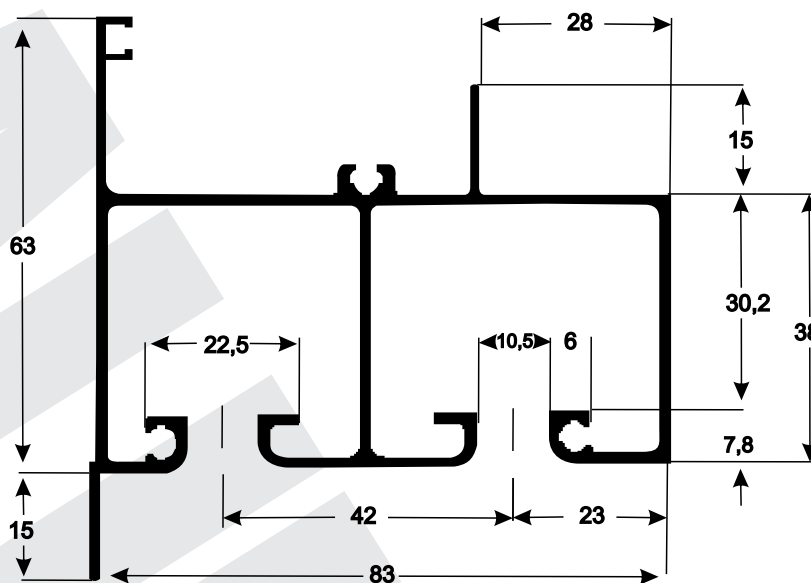

E-279
1,690 kg/m

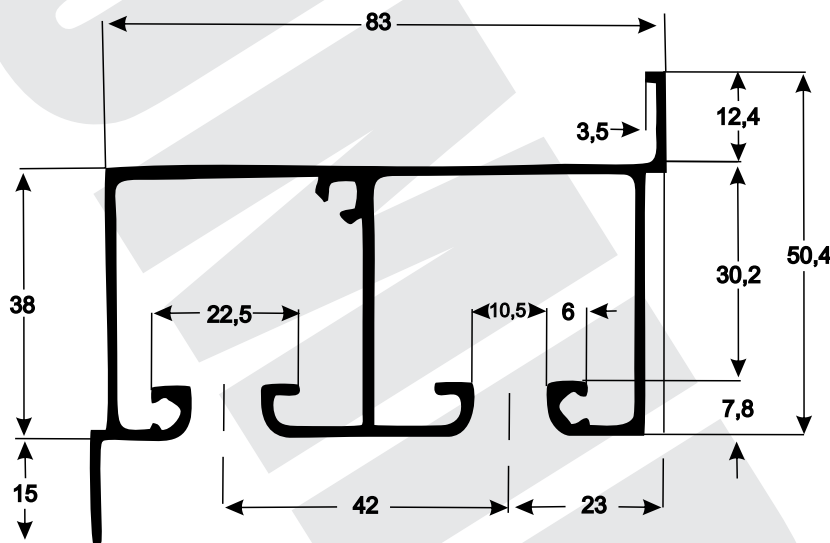

E-280
1,699 kg/m

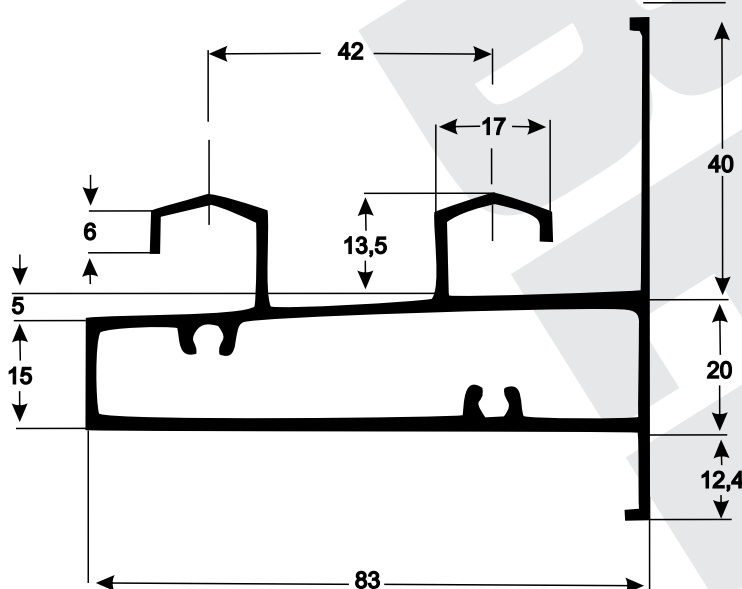

P-257
1,566 kg/m

ALUMIBEL

Comércio de Alumínio e Acessórios

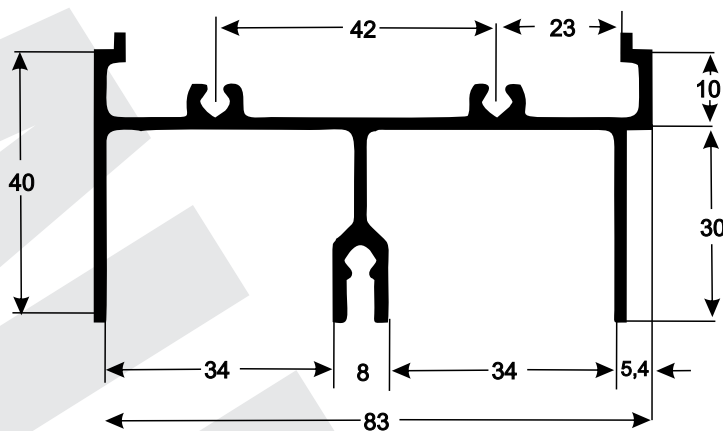

E-291
1,095 kg/m

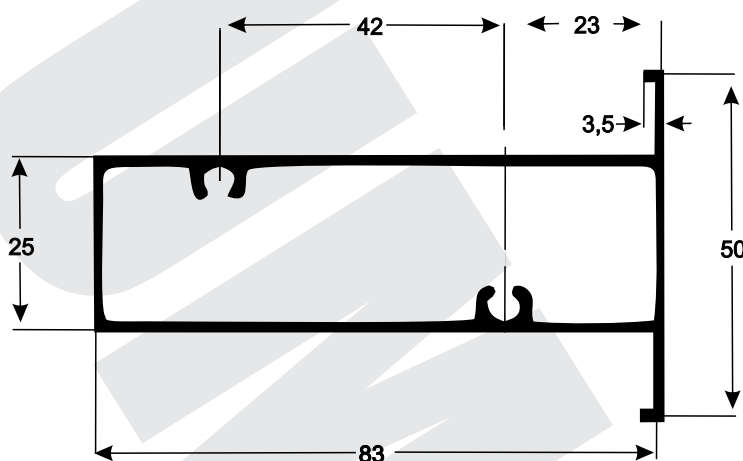

P-258
1,187 kg/m

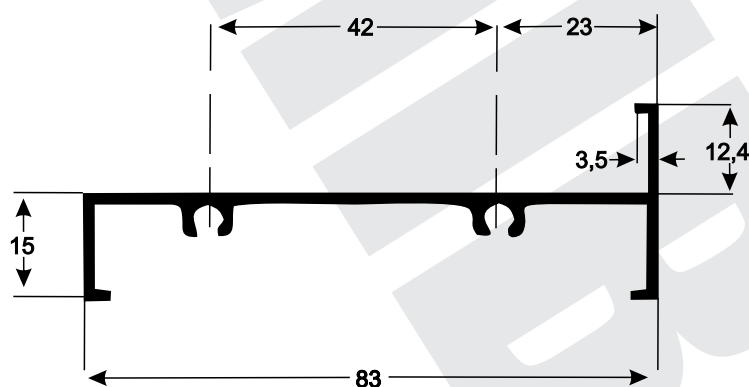

Z-182
0,662 kg/m

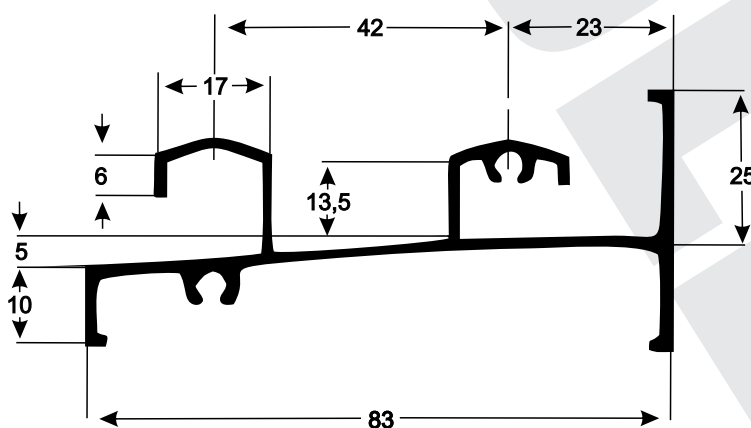

Z-183
0,989 kg/m

ALUMIBEL

Comércio de Alumínio e Acessórios

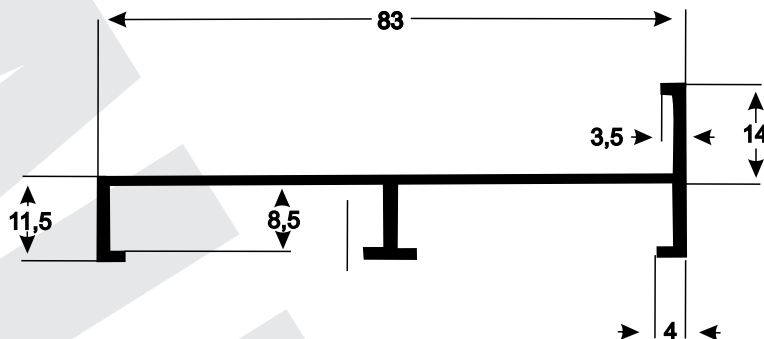

Z-181
0,564 kg/m

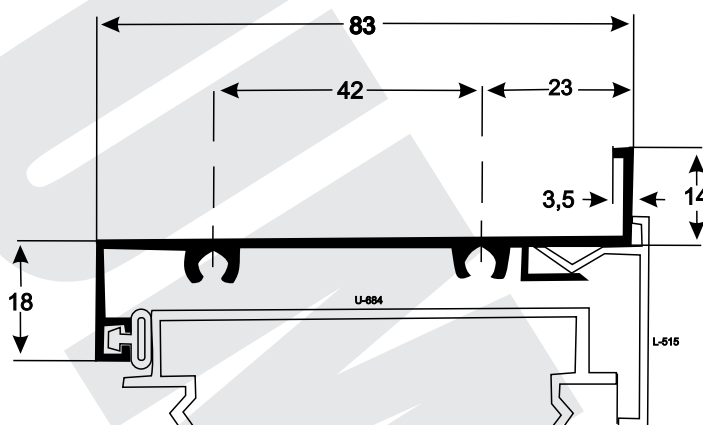

Z-184
0,678 kg/m

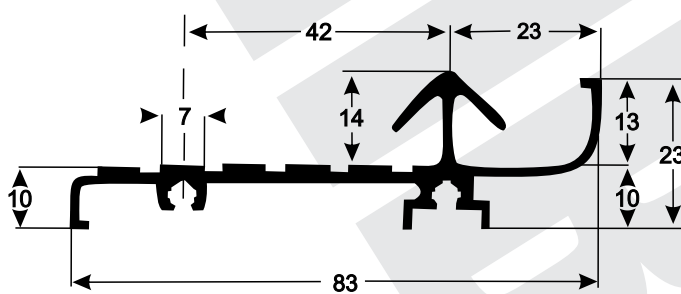

Z-185
0,894 kg/m

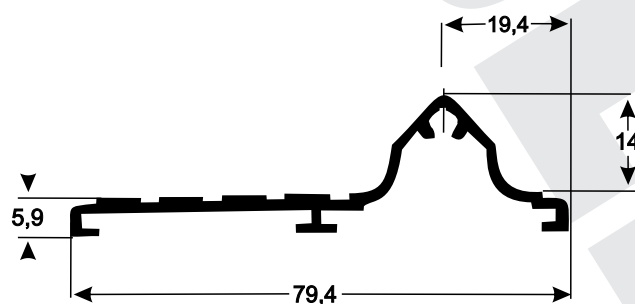

E-282
0,600 kg/m

ALUMIBEL

Comércio de Alumínio e Acessórios

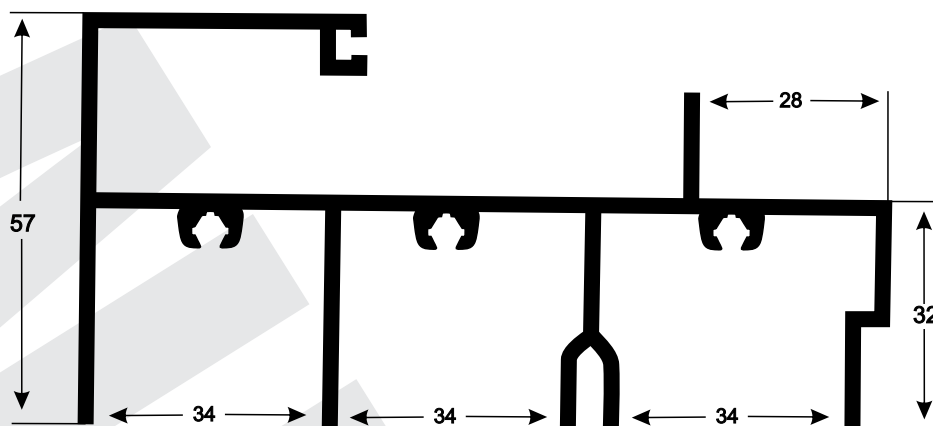

E-344
1,787 kg/m

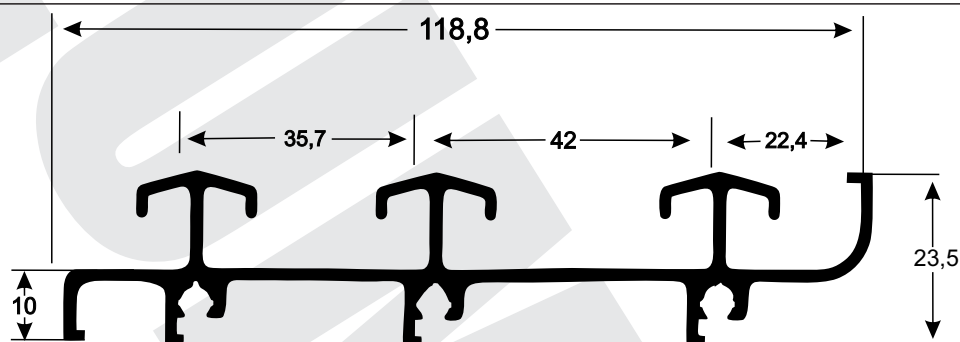

Z-204
1,372 kg/m

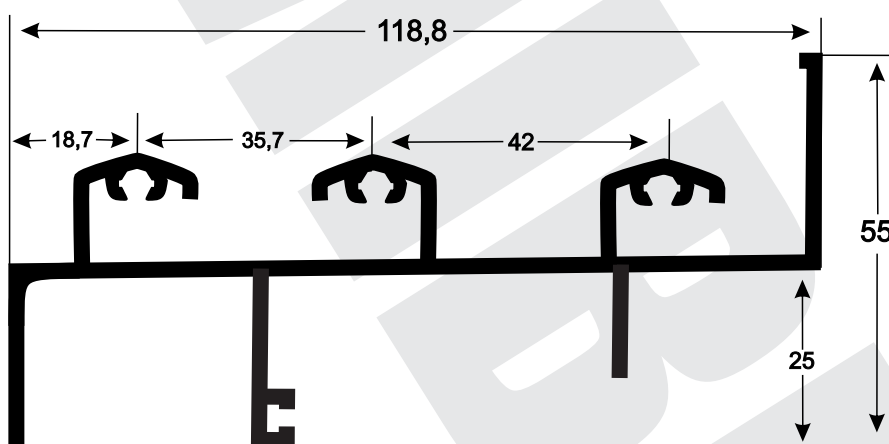

E-345
1,582 kg/m

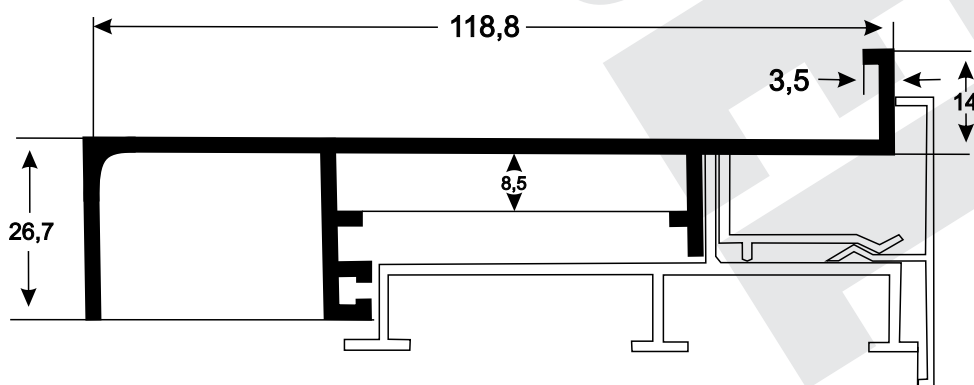

Z-205
0,980 kg/m

ALUMIBEL

Comércio de Alumínio e Acessórios

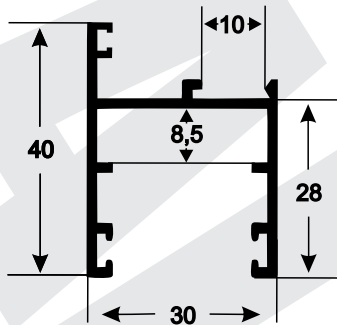

Y-131
0,506 kg/m

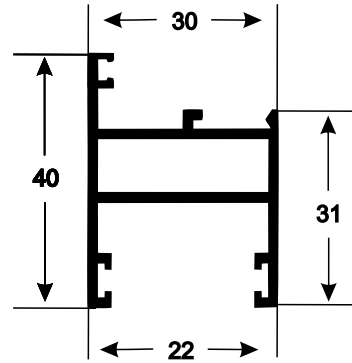

A-030
0,596 kg/m

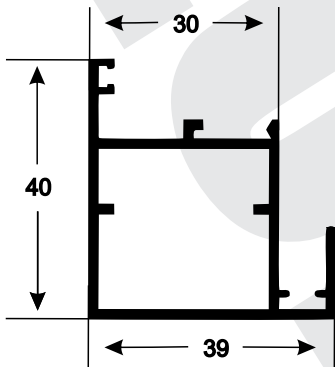

P-149
0,660 kg/m

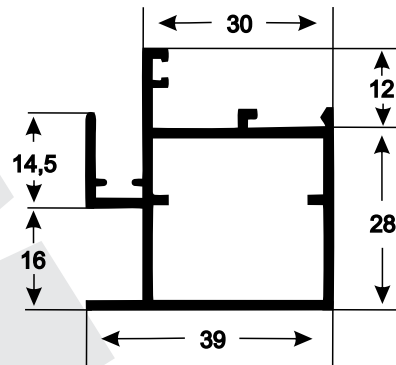

P-148
0,705 kg/m

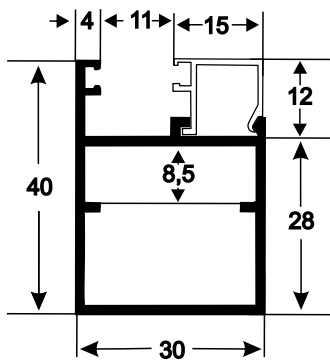

P-084
0,561 kg/m

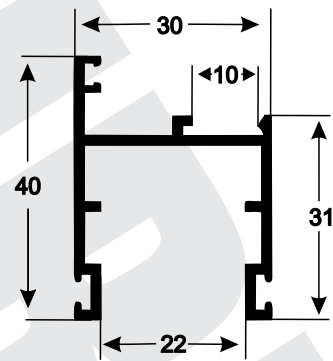

Y-153
0,500 kg/m

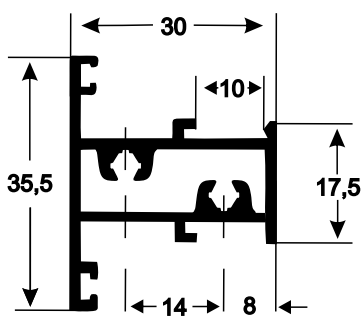

P-075
0,607 kg/m

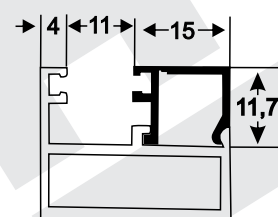

U-482
0,115 kg/m

ALUMIBEL

Comércio de Alumínio e Acessórios

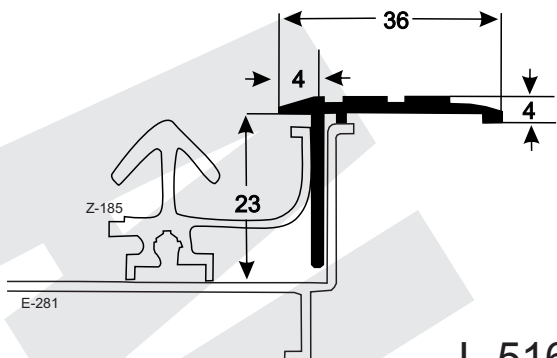

L-516
0,339 kg/m

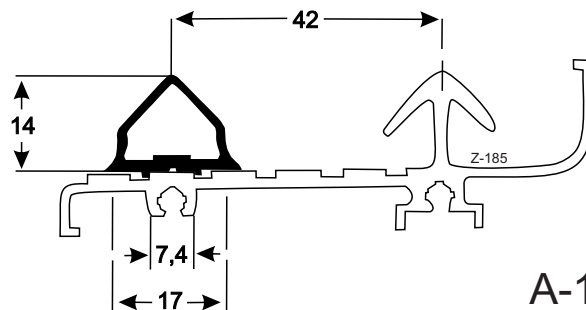

A-101
0,260 kg/m

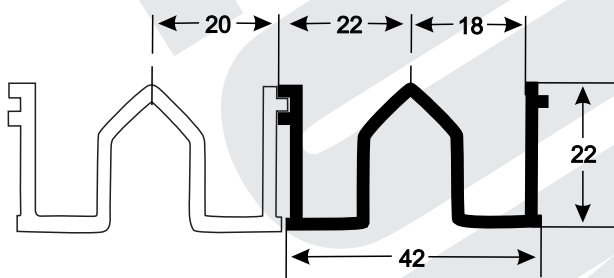

E-283
0,600 kg/m

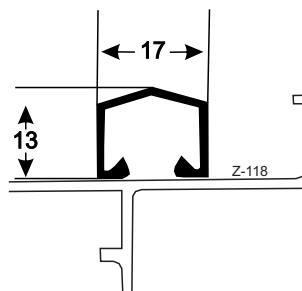

U-685
0,168 kg/m

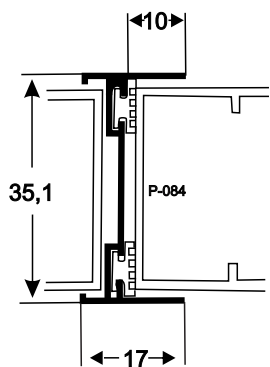

E-150
0,285 kg/m

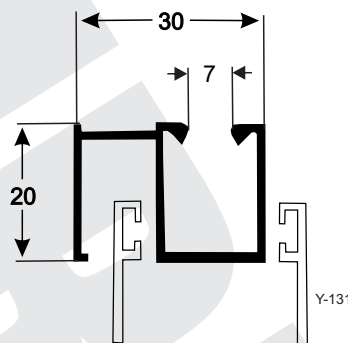

Z-082
0,340 kg/m

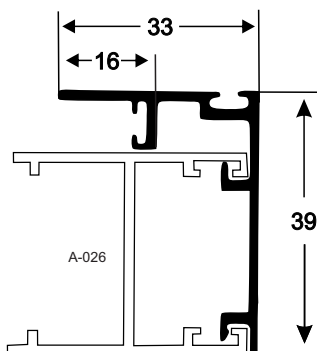

L-517
0,401 kg/m

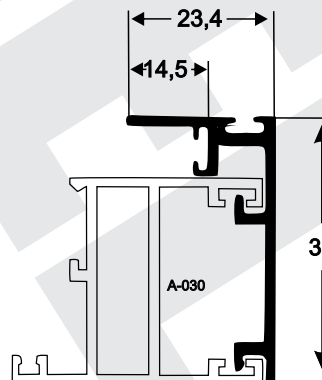

L-518
0,366 kg/m

ALUMIBEL

Comércio de Alumínio e Acessórios

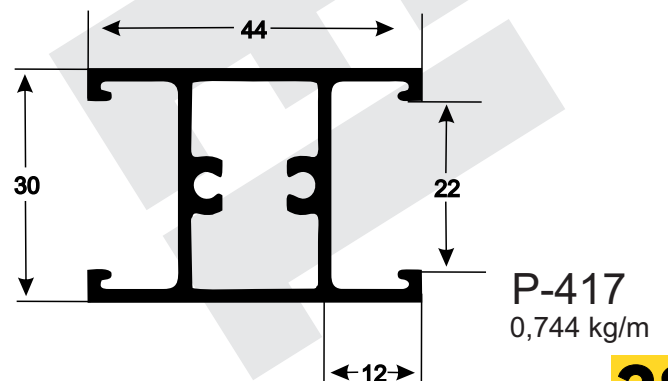
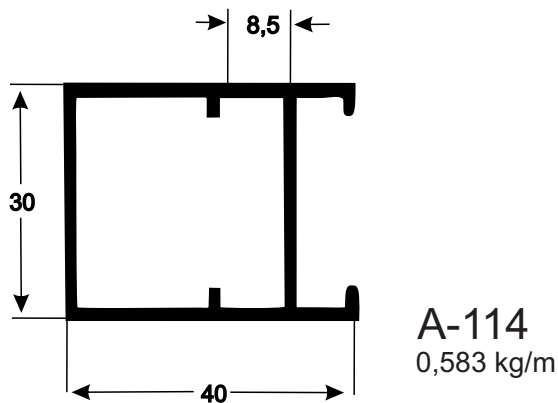
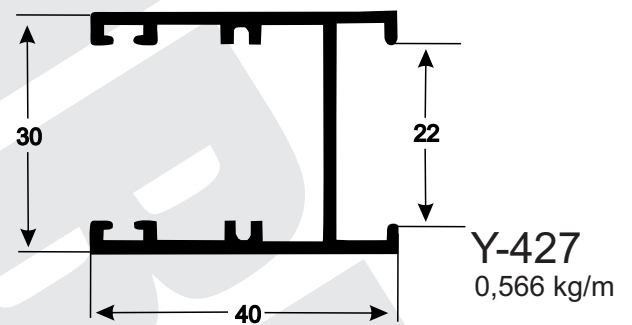
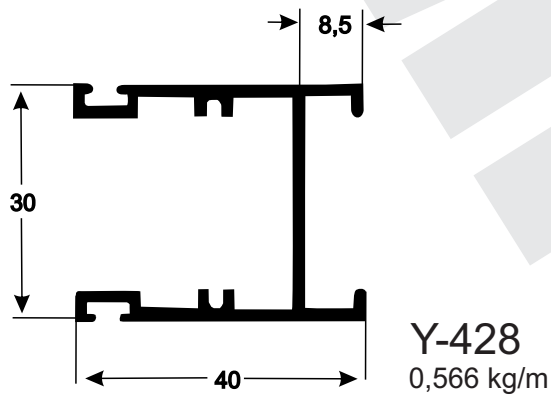
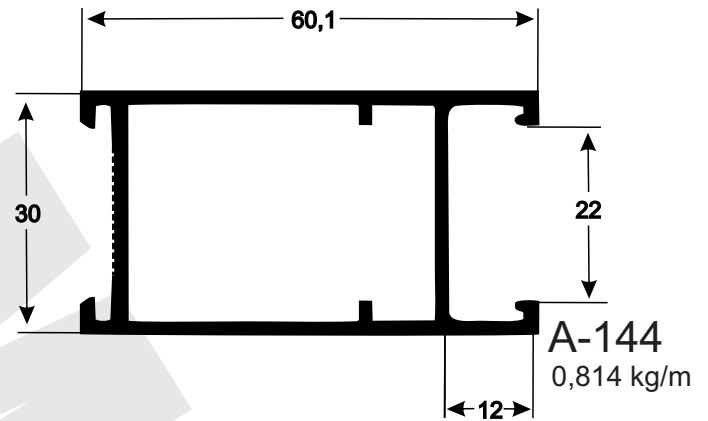
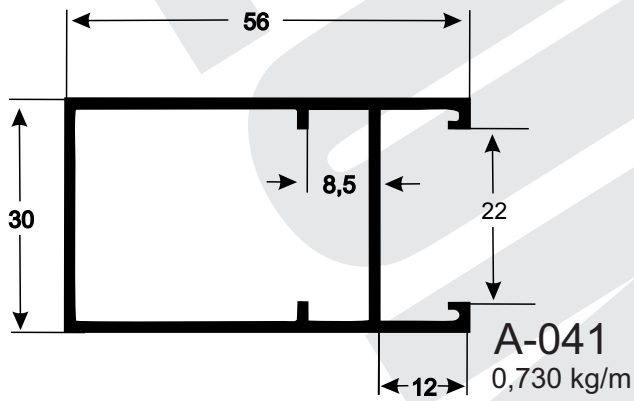
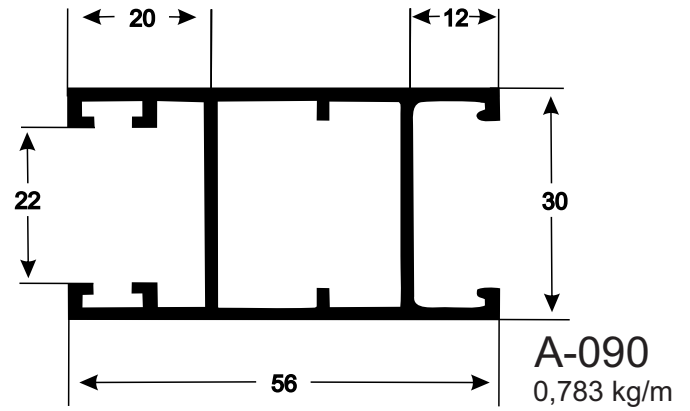
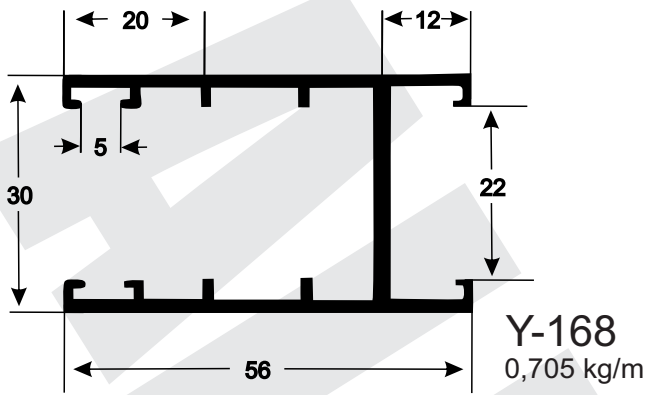

ALUMIBEL

Comércio de Alumínio e Acessórios

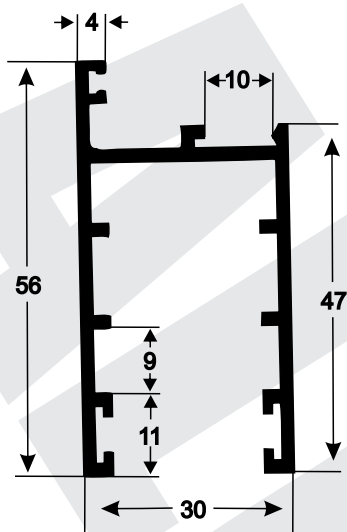

Y-110
0,653 kg/m

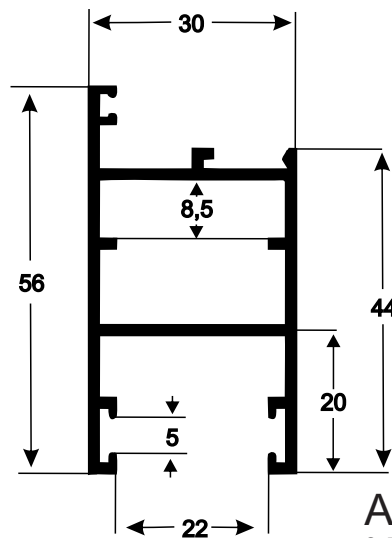

A-026
0,750 kg/m

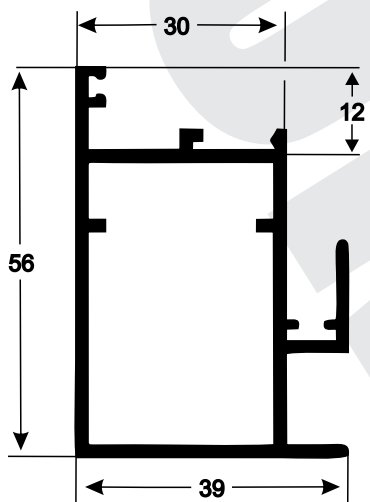

P-281
0,843 kg/m

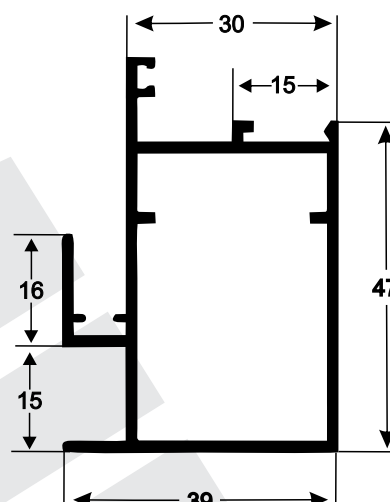

P-282
0,832 kg/m

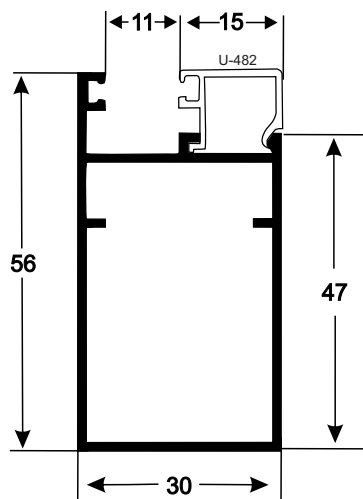

P-068
0,694 kg/m

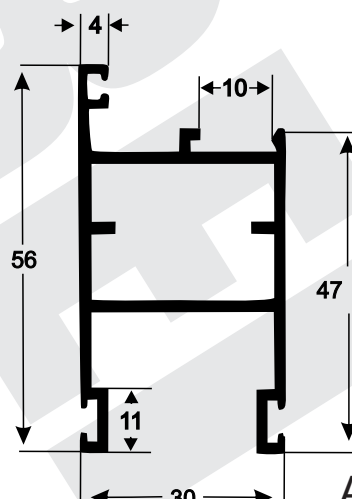

A-054
0,750 kg/m

ALUMIBEL

Comércio de Alumínio e Acessórios

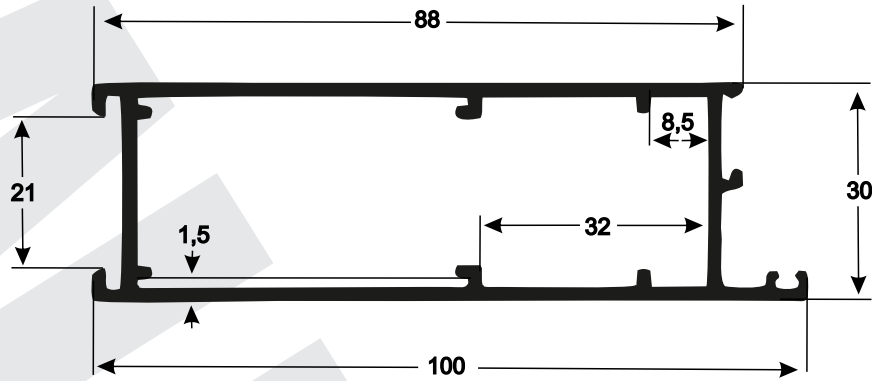

P-264
1,219 kg/m

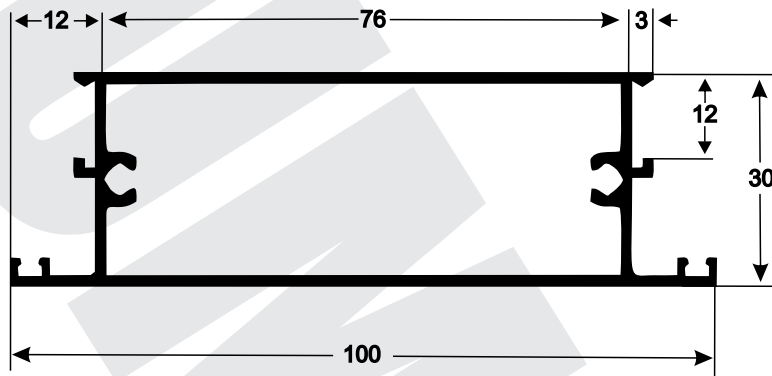

P-165
1,244 kg/m

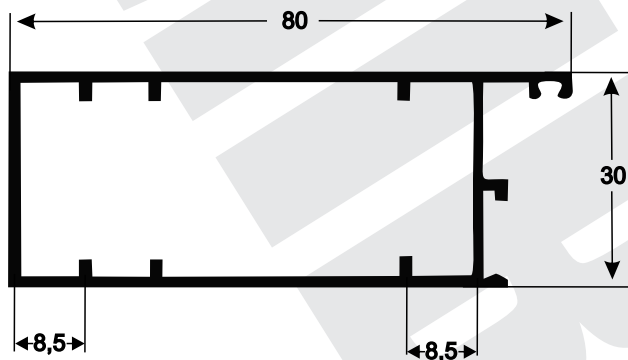

P-358
0,973 kg/m

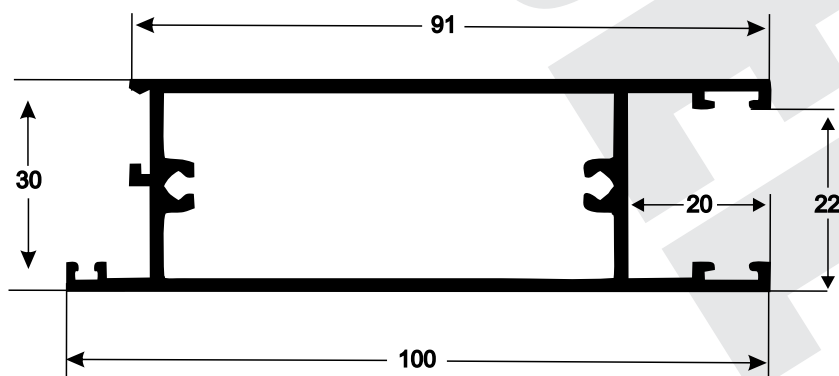

A-081
1,300 kg/m

ALUMIBEL

Comércio de Alumínio e Acessórios

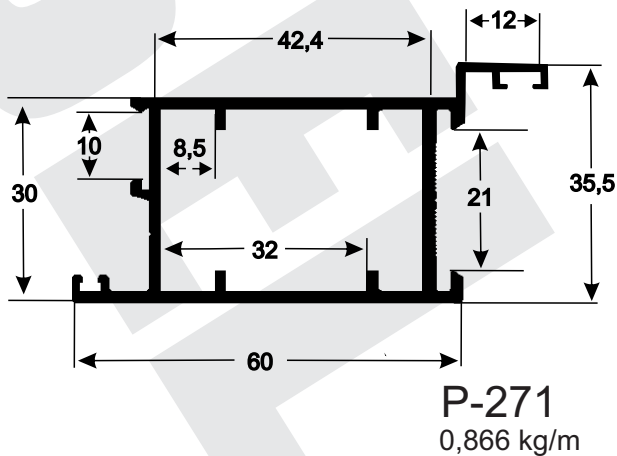
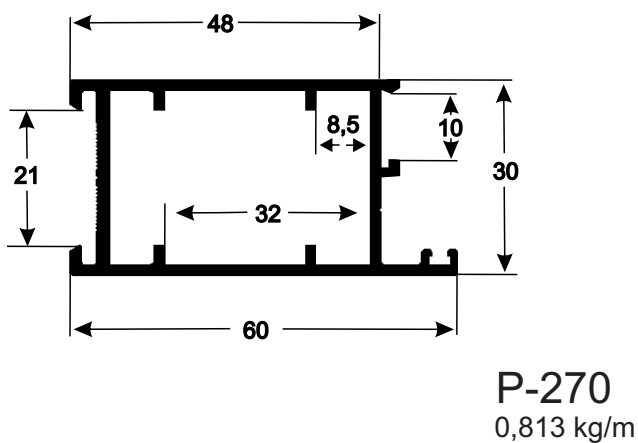
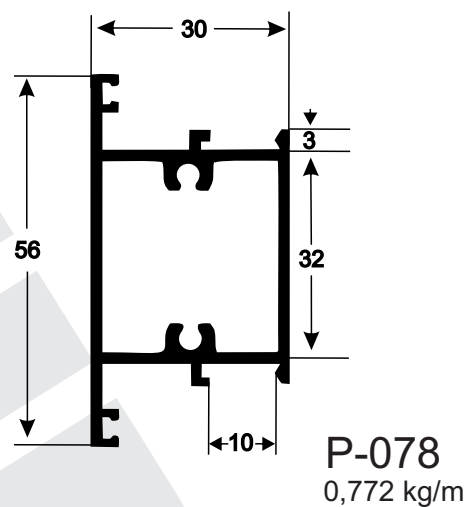
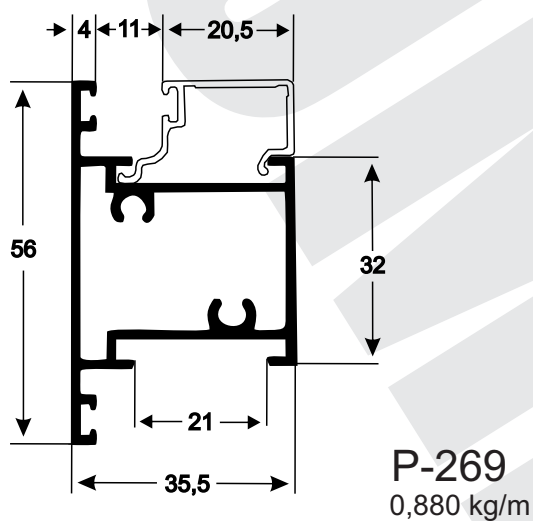
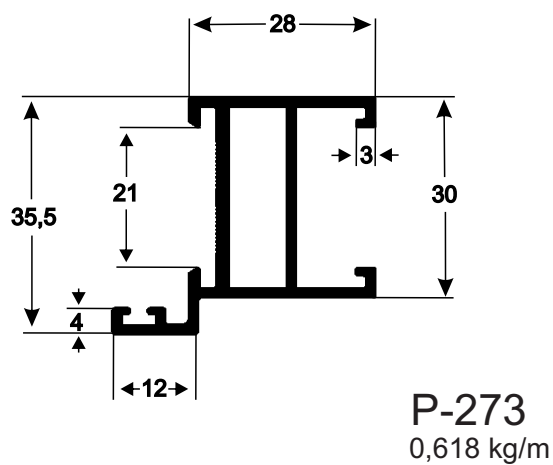
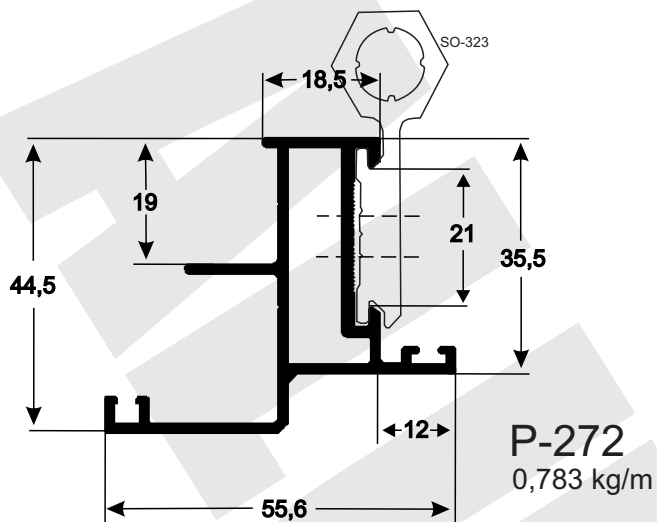

ALUMIBEL

Comércio de Alumínio e Acessórios

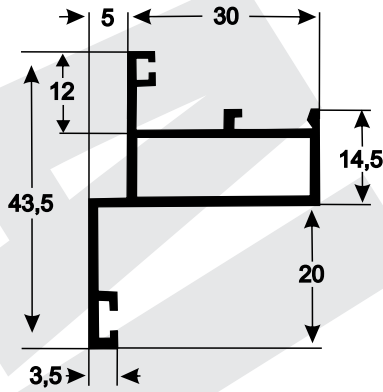

P-120
0,535 kg/m

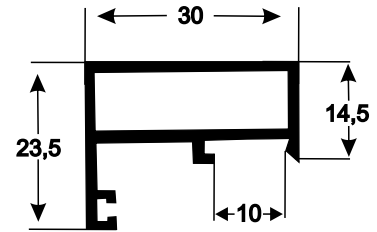

P-064
0,400 kg/m

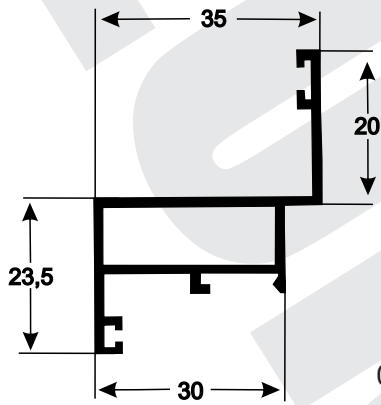

P-121
0,535 kg/m

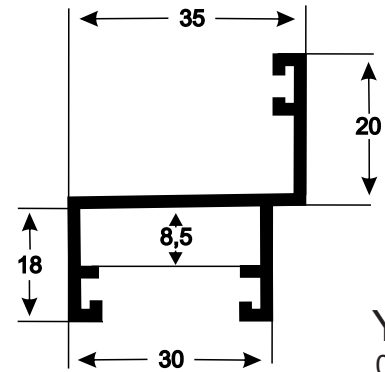

Y-140
0,428 kg/m

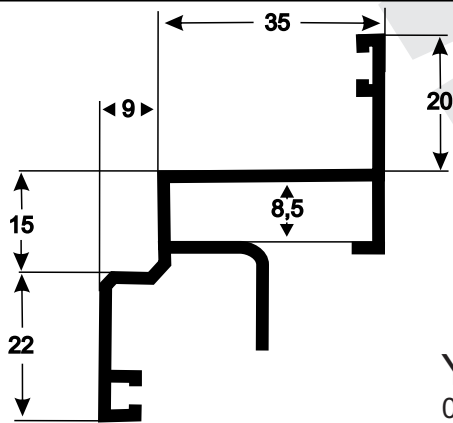

Y-214
0,600 kg/m

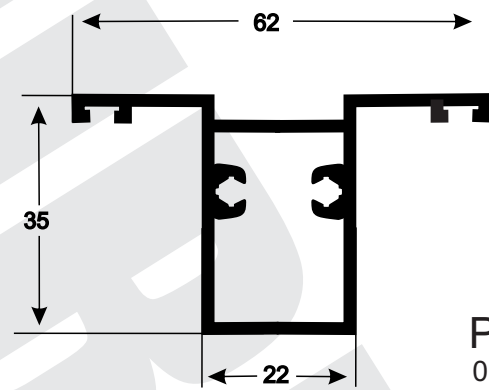

P-419
0,726 kg/m

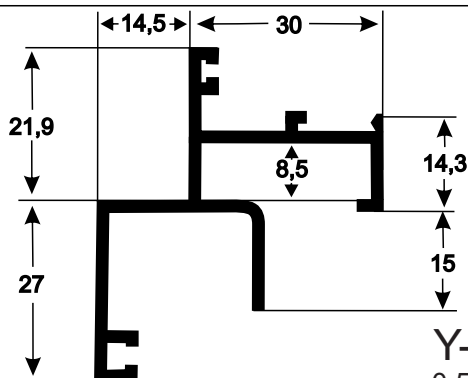

Y-202
0,566 kg/m

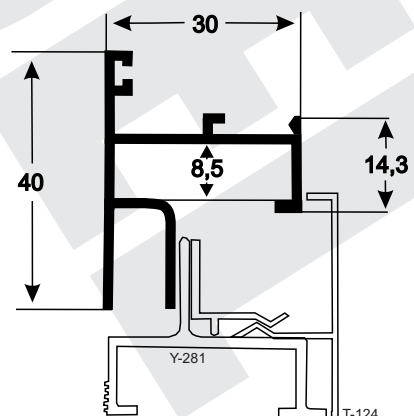

Y-344
0,450 kg/m

ALUMIBEL

Comércio de Alumínio e Acessórios

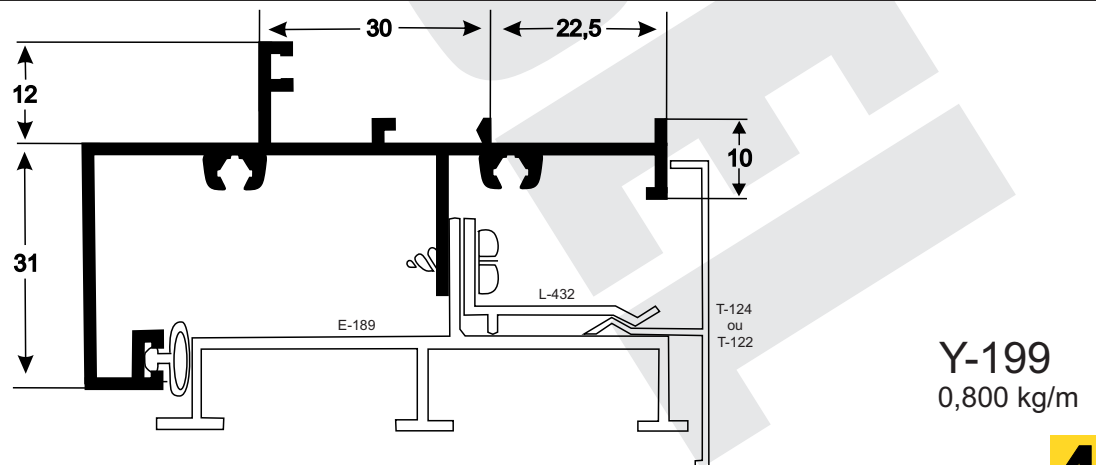
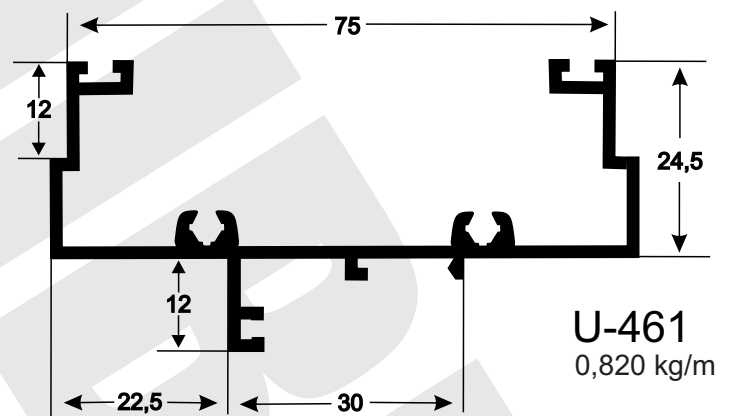
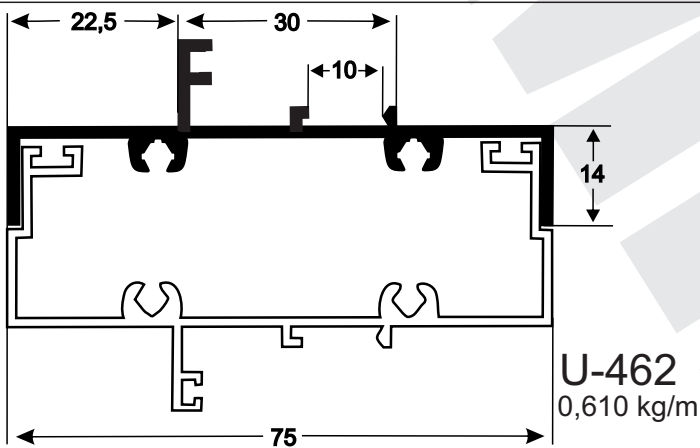
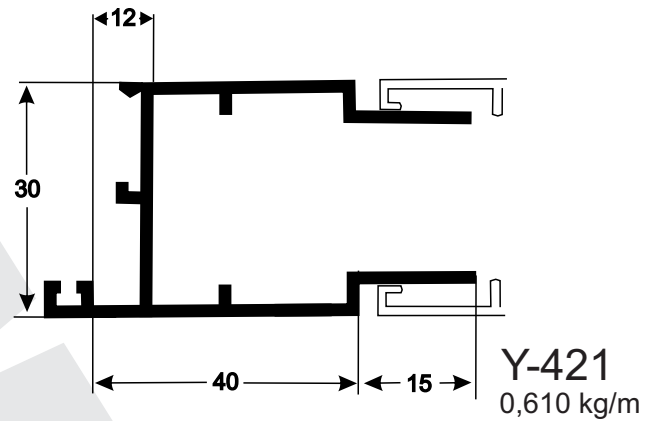
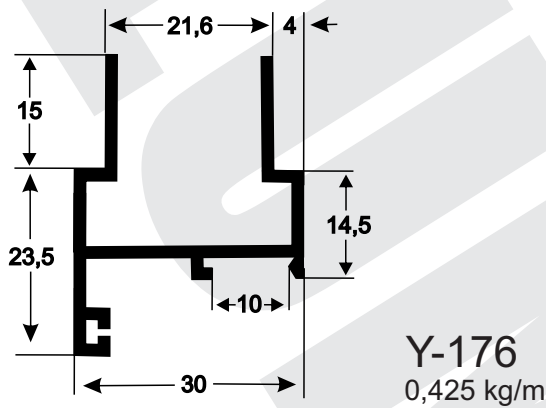
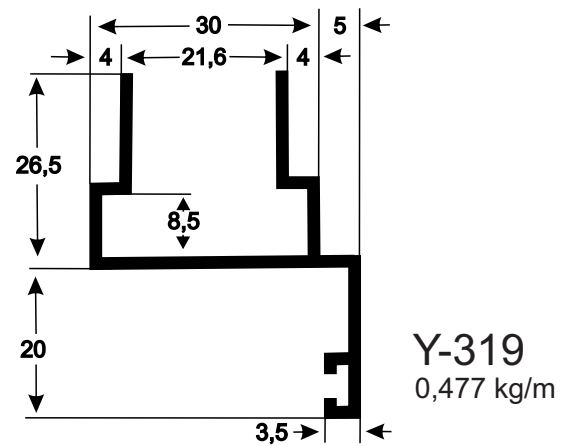
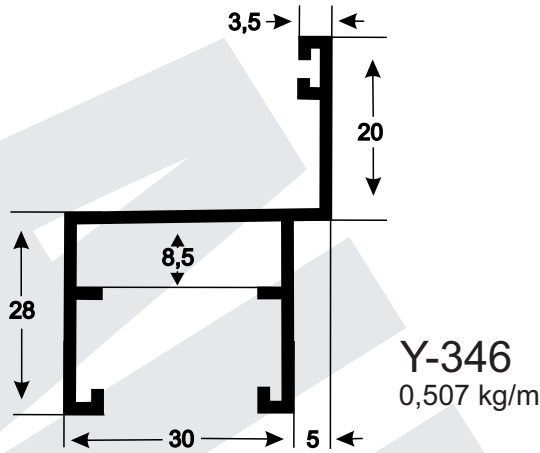

ALUMIBEL

Comércio de Alumínio e Acessórios

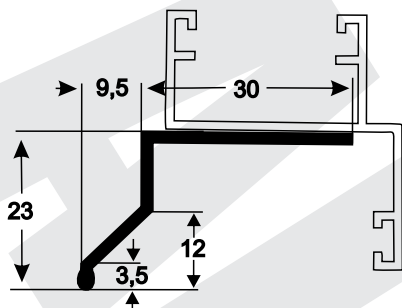

L-332
0,210 kg/m

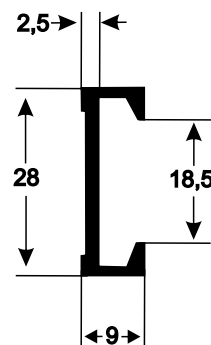

U-690
0,260 kg/m

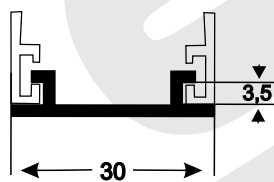

I-086
0,220 kg/m

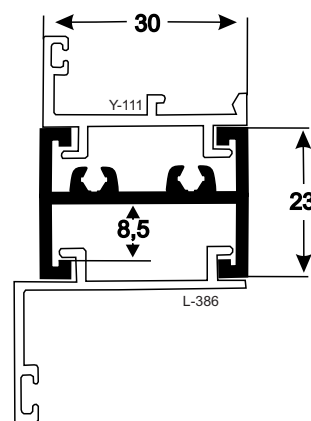

I-102
0,460 kg/m

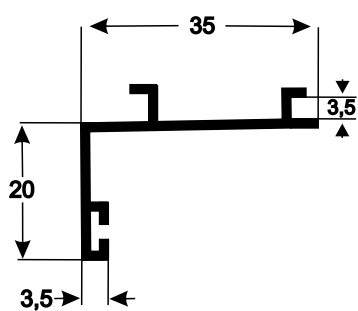

L-366
0,282 kg/m

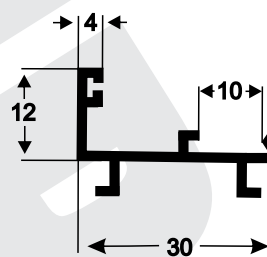

Y-111
0,276 kg/m

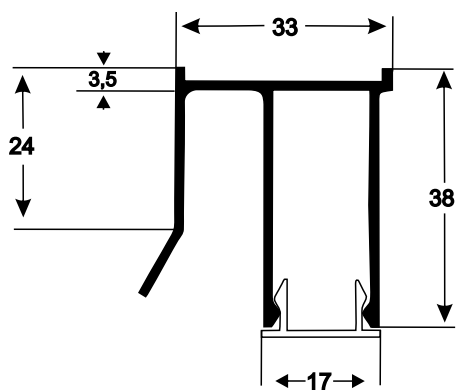

E-161
0,600 kg/m

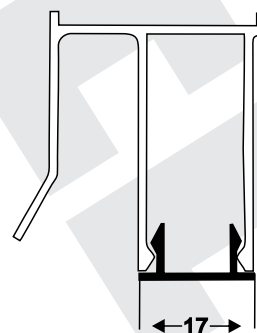

U-491
0,100 kg/m

ALUMIBEL

Comércio de Alumínio e Acessórios

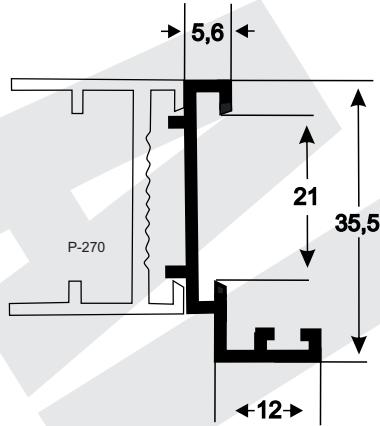

L-519
0,300 kg/m

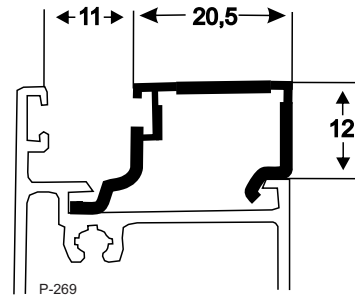

U-679
0,180 kg/m

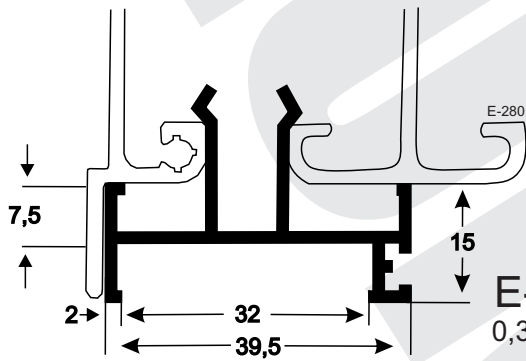

E-284
0,375 kg/m

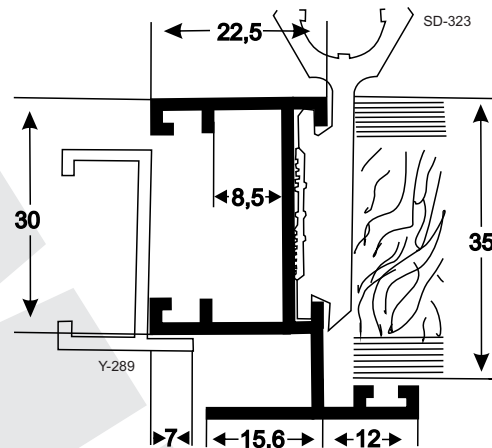

Y-342
0,575 kg/m

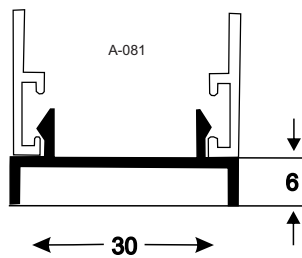

U-704
0,187 kg/m

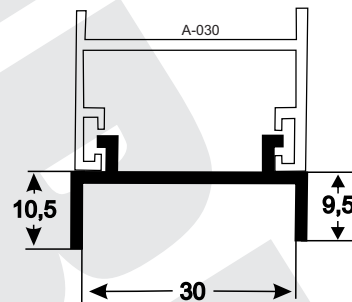

U-406
0,260 kg/m

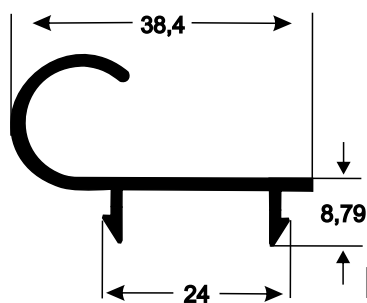

L-571
0,322 kg/m

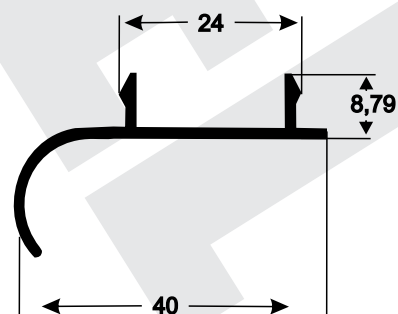

L-570
0,288 kg/m

ALUMIBEL

Comércio de Alumínio e Acessórios

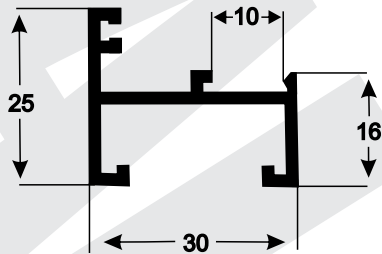

Y-113
0,345 kg/m

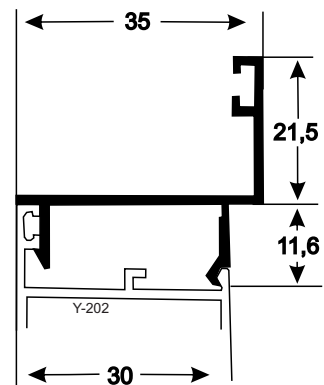

Y-148
0,330 kg/m

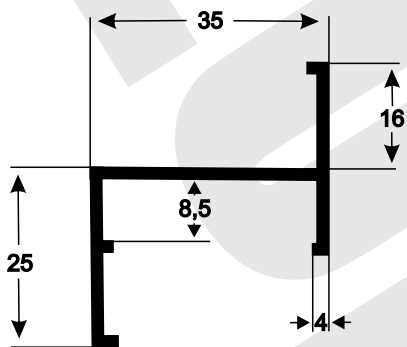

Y-147
0,390 kg/m

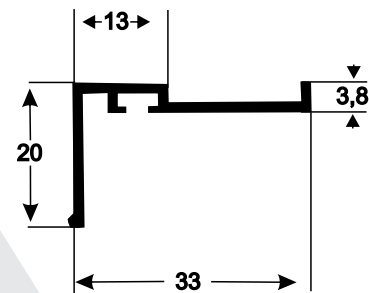

L-387
0,220 kg/m

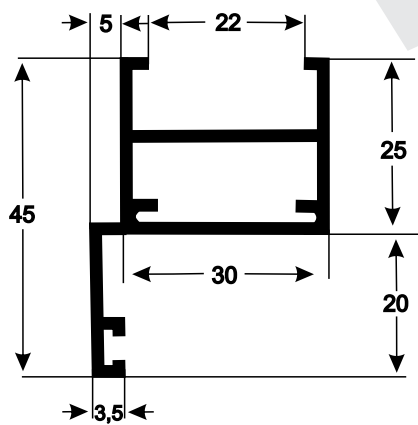

P-156
0,600 kg/m

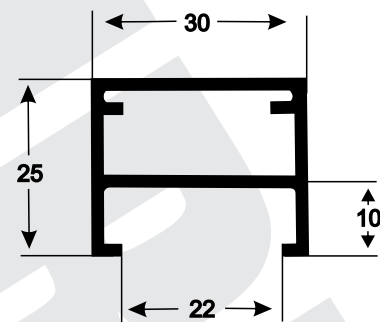

A-057
0,470 kg/m

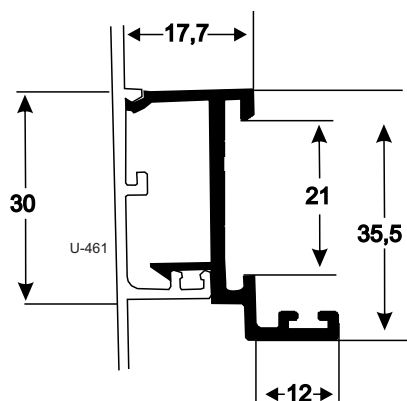

Y-348
0,407 kg/m

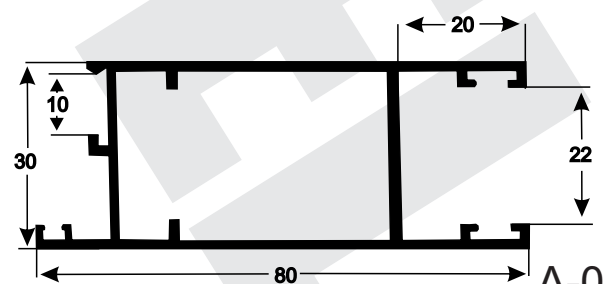

A-046
1,040 kg/m

ALUMIBEL

Comércio de Alumínio e Acessórios

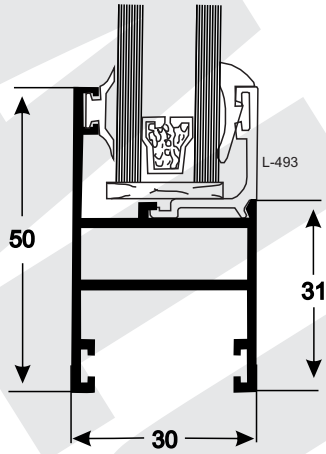

A-088
0,650 kg/m

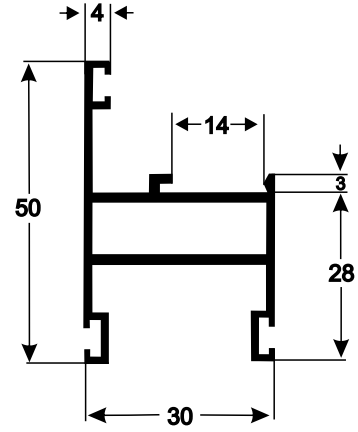

A-102
0,660 kg/m

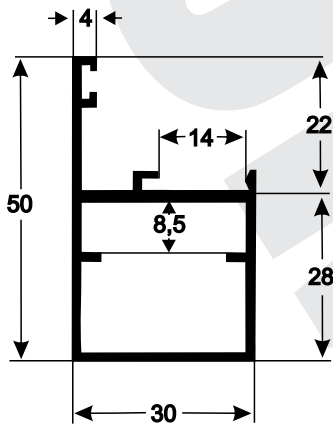

P-275
0,626 kg/m

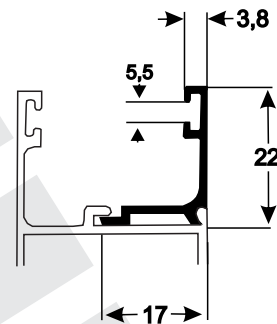

L-493
0,165 kg/m

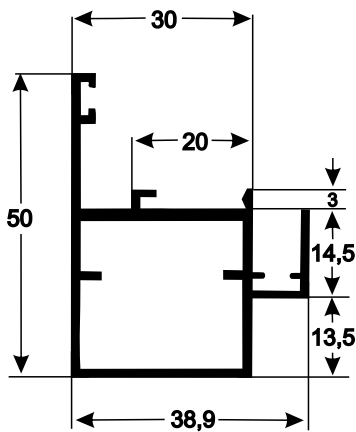

P-276
0,724 kg/m

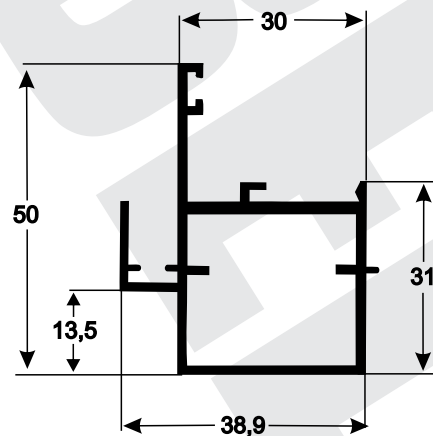

P-277
0,724 kg/m

ALUMIBEL

Comércio de Alumínio e Acessórios

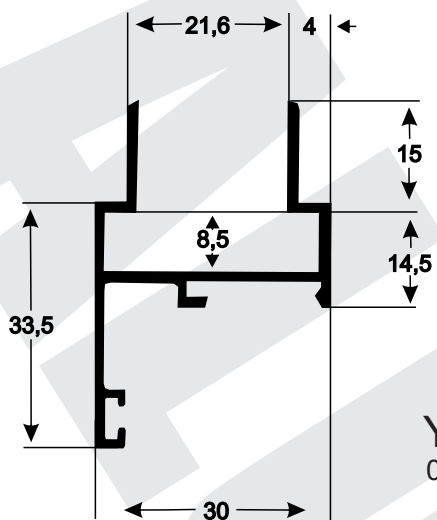

Y-318
0,505 kg/m

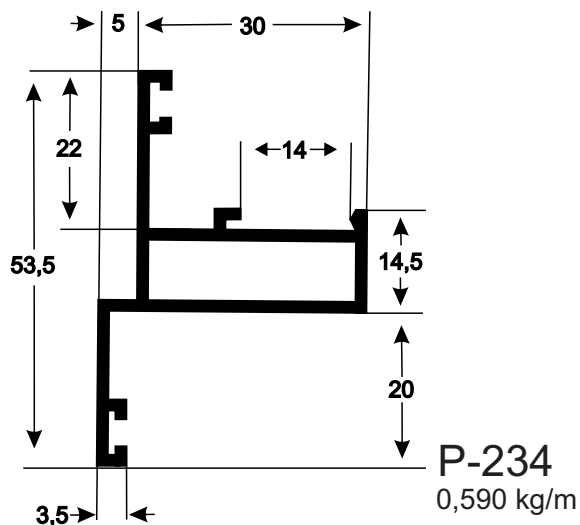

P-234
0,590 kg/m

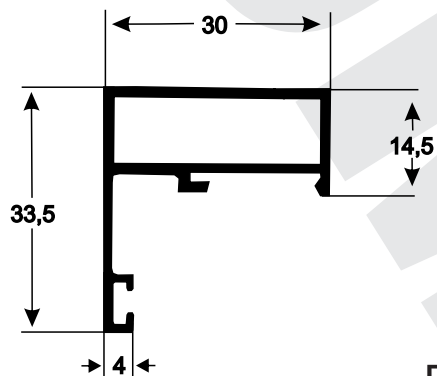

P-233
0,460 kg/m

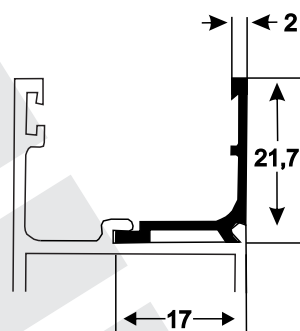

L-590
0,150 kg/m

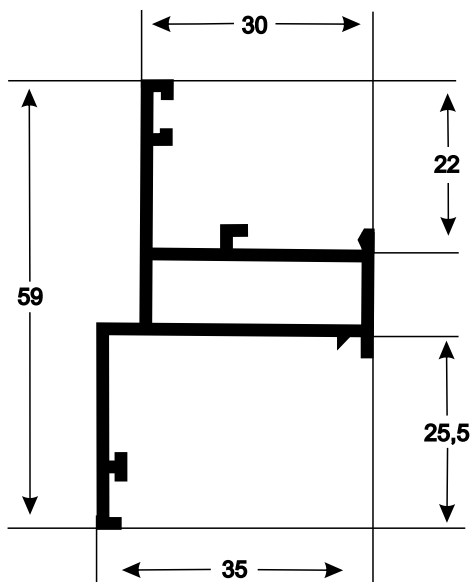

P-406
0,612 kg/m

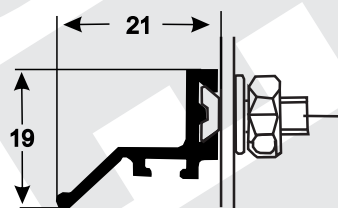

L-589
0,175 kg/m

ALUMIBEL

Comércio de Alumínio e Acessórios

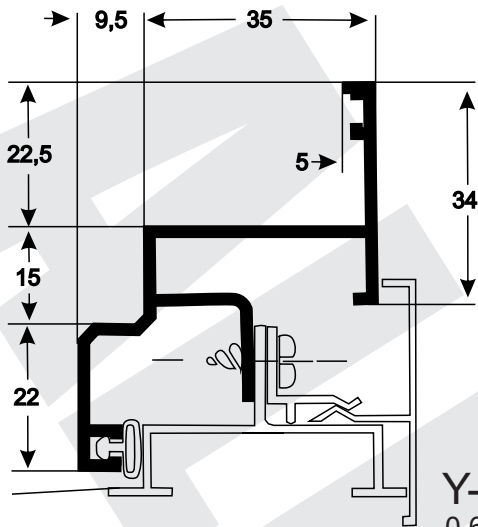

Y-440
0,623 kg/m

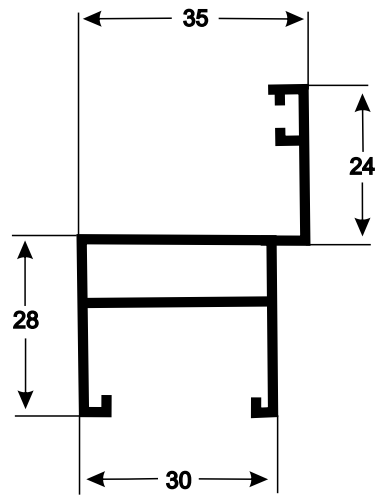

A-122
0,618 kg/m

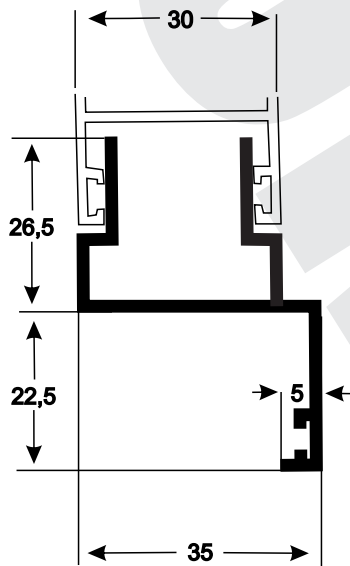

Y-441
0,496 kg/m

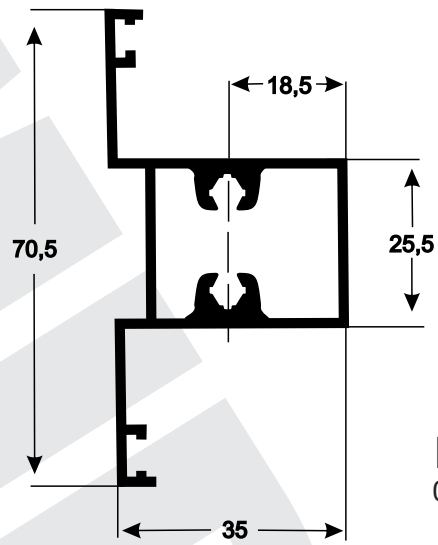

P-377
0,799 kg/m

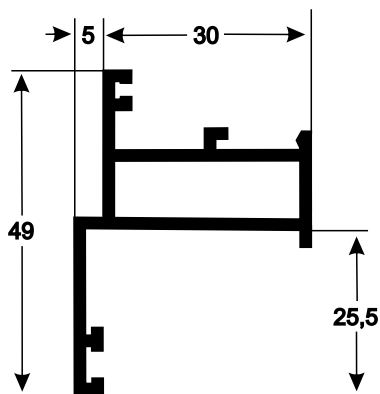

P-378
0,572 kg/m

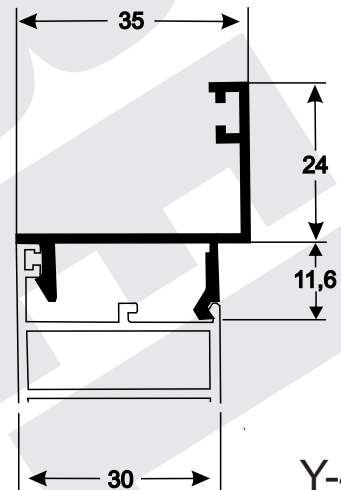

Y-439
0,341 kg/m

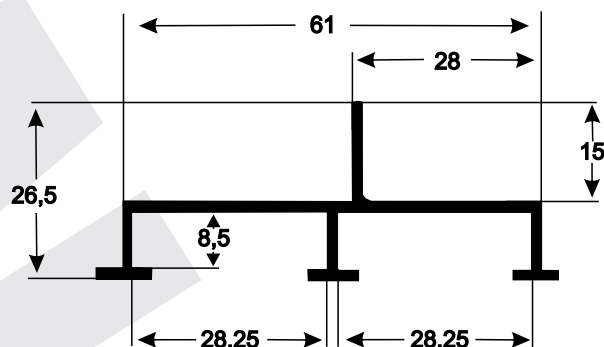

E-189
0,482 kg/m

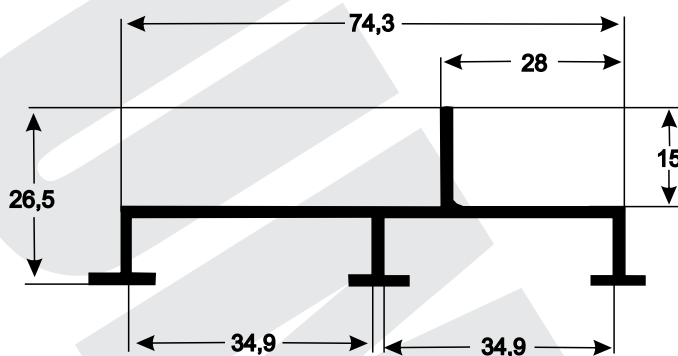

E-184
0,528 kg/m

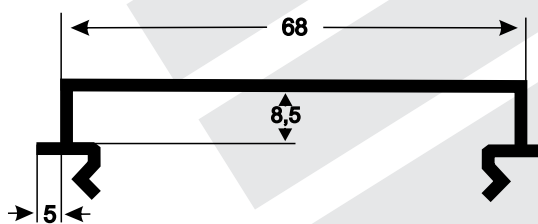

U-684
0,458 kg/m

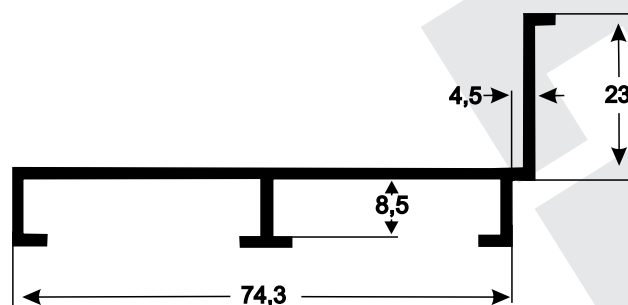

E-281
0,577 kg/m

ALUMIBEL

CONTRAMARCOS

Comércio de Alumínio e Acessórios

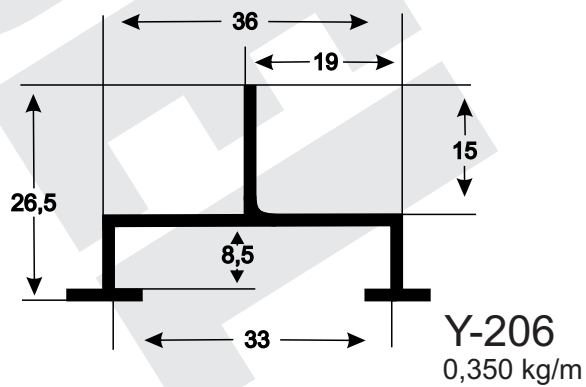
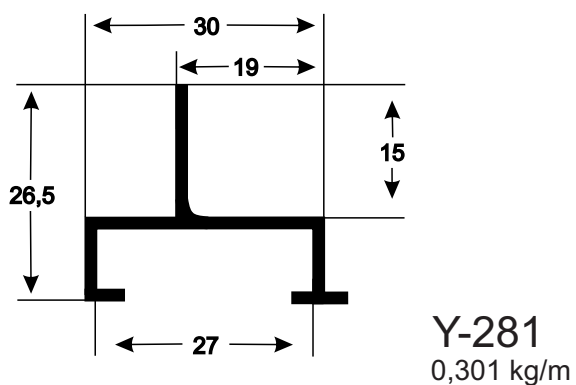
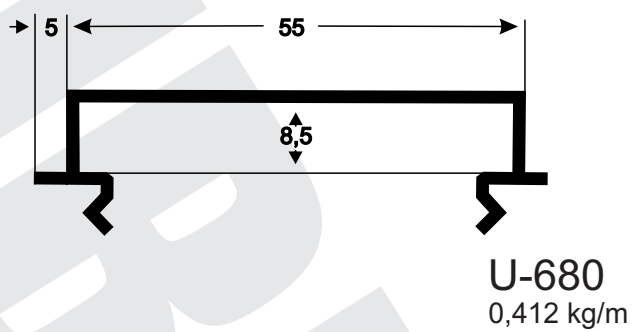
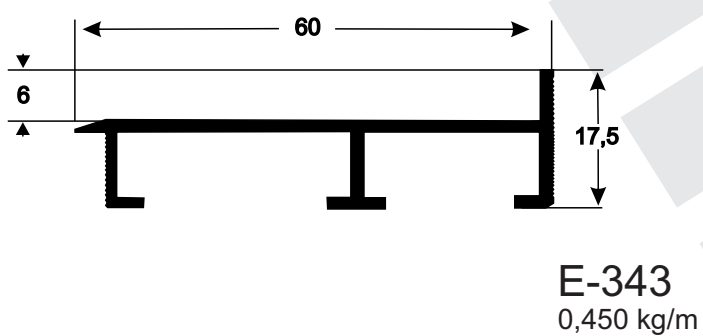
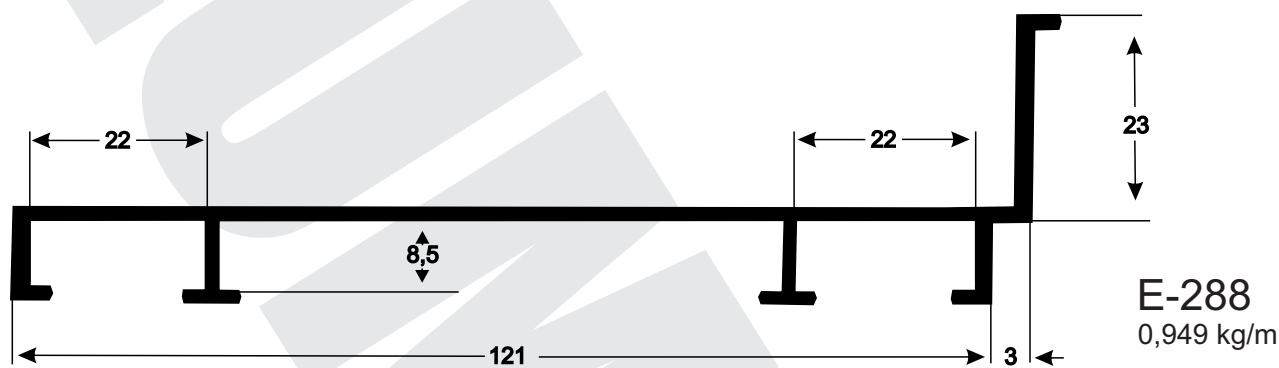
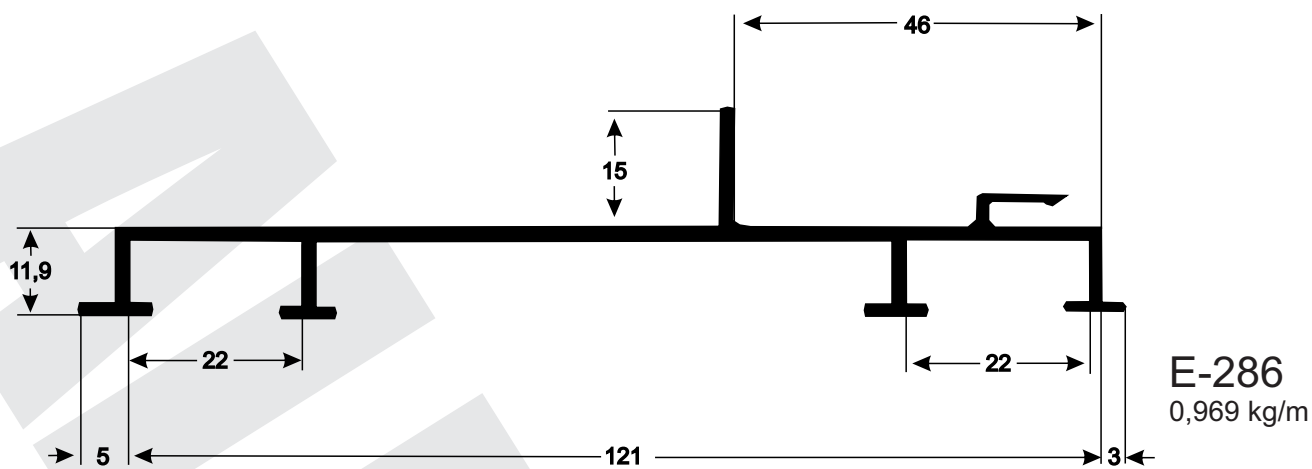

ALUMIBEL

ARREMATES PARA
CONTRAMARCOS

Comércio de Alumínio e Acessórios

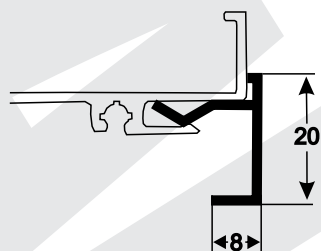

L-513
0,122 kg/m

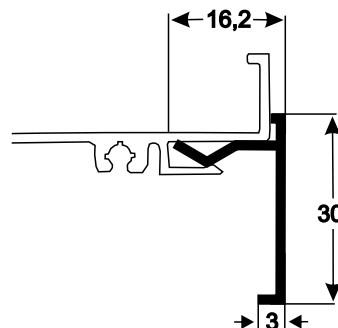

L-515
0,135 kg/m

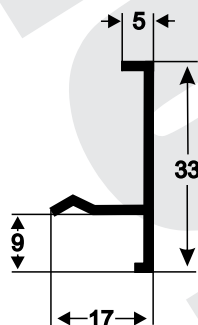

T-122
0,150 kg/m

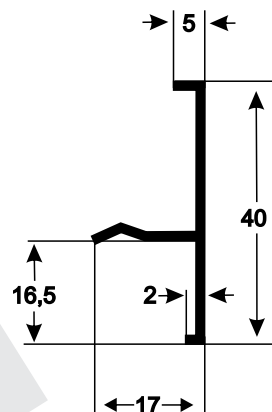

T-124
0,175 kg/m

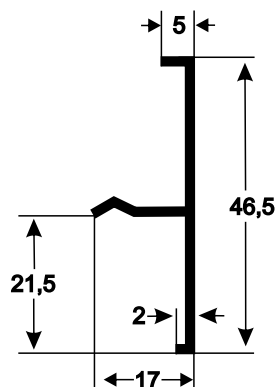

T-136
0,185 kg/m

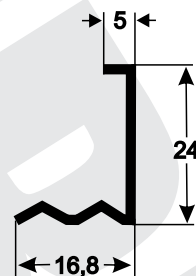

L-477
0,136 kg/m

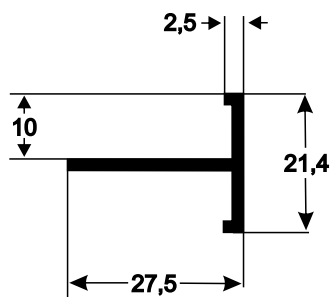

T-155
0,184 kg/m

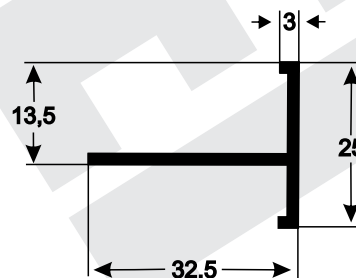

T-102
0,245 kg/m

ALUMIBEL

CONTRAMARCOS
E ARREMATES

Comércio de Alumínio e Acessórios

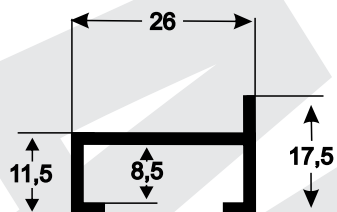

Y289
0,249 kg/m

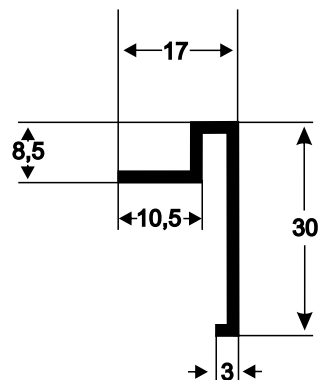

L-469
0,179 kg/m

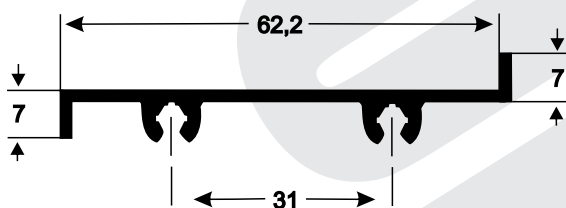

Z-195
0,412 kg/m

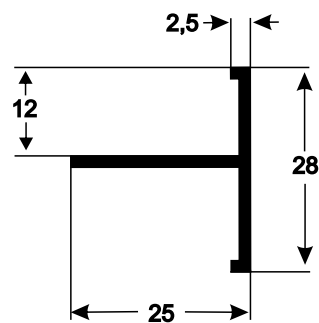

T-095
0,202 kg/m

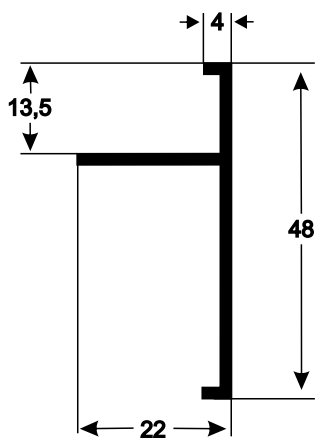

T-105
0,300 kg/m

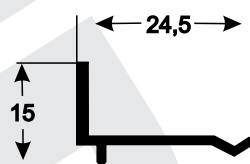

L-432
0,127 kg/m

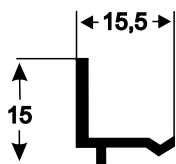

L-431
0,100 kg/m

ALUMIBEL

CONEXÕES

Comércio de Alumínio e Acessórios

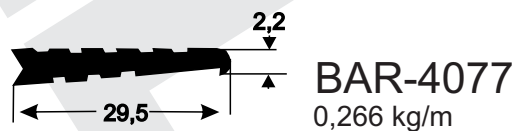
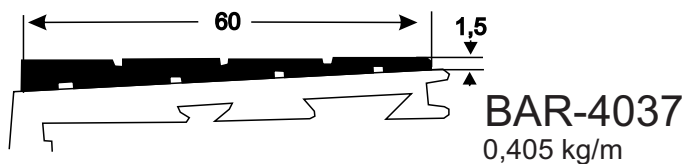
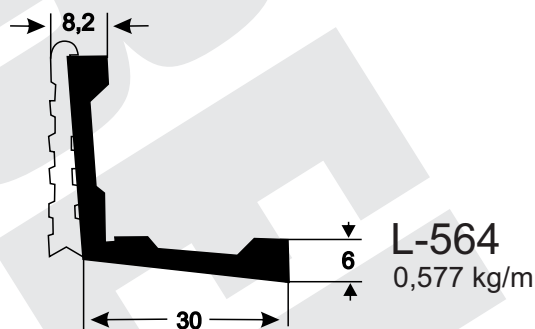
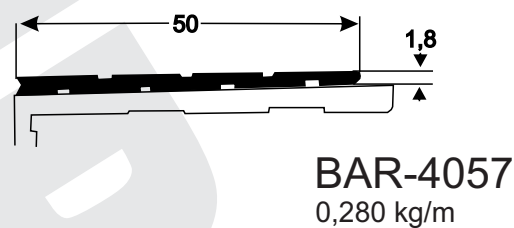
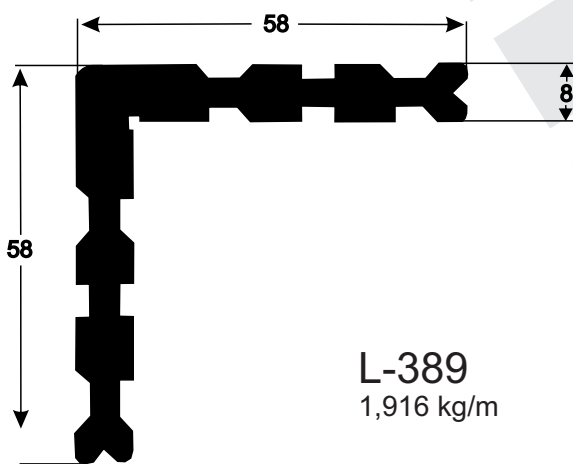
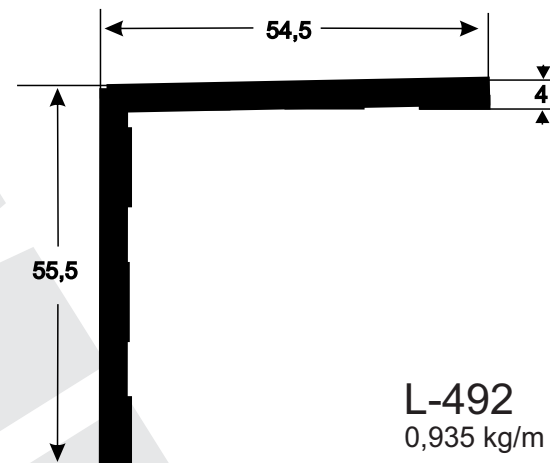
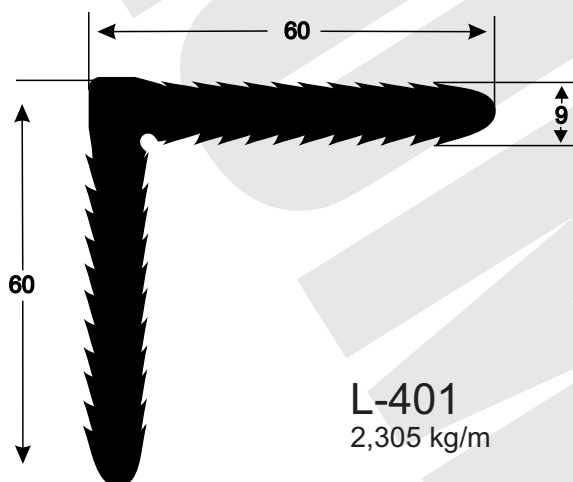
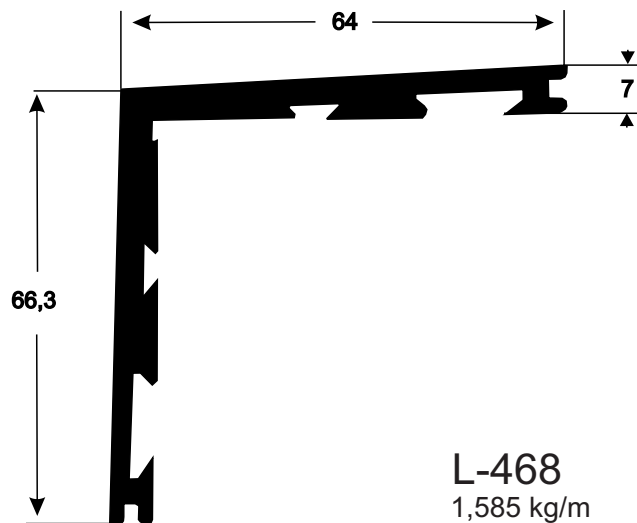
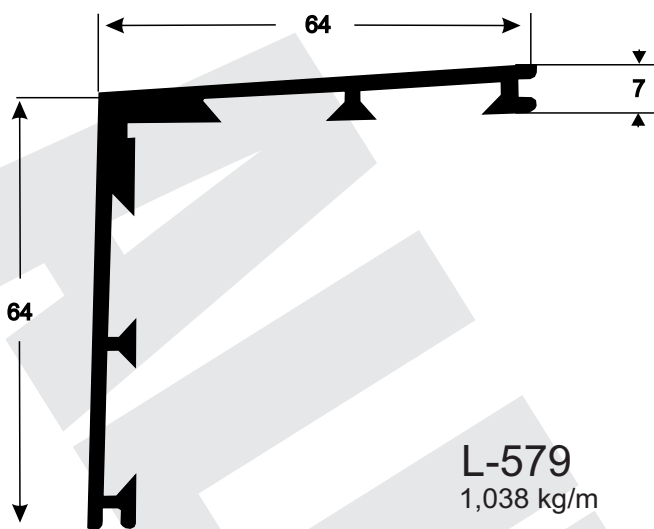

ALUMIBEL

PERFIS DIVERSOS
PARA CAIXILHARIA

Comércio de Alumínio e Acessórios

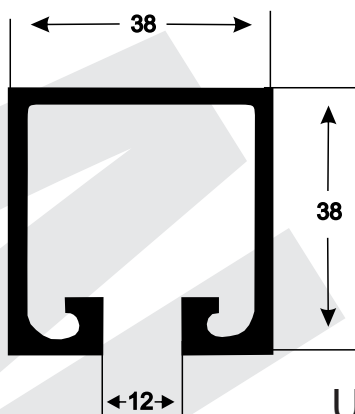

U-163
0,980 kg/m

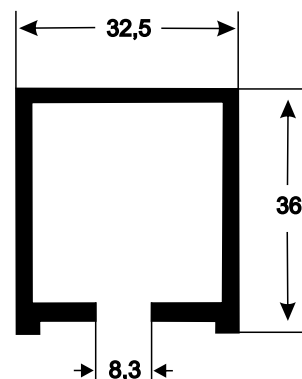

U-164
0,705 kg/m

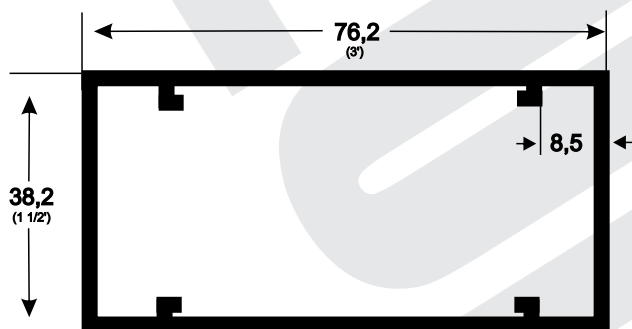

D-069
1,110 kg/m

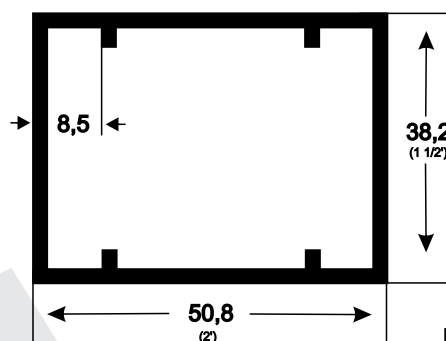

D-078
0,794 kg/m

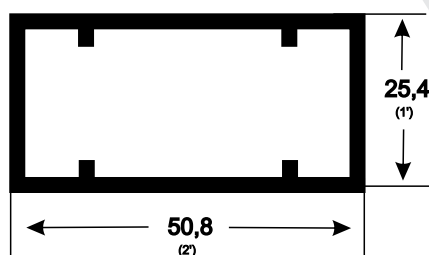

D-079
0,645 kg/m

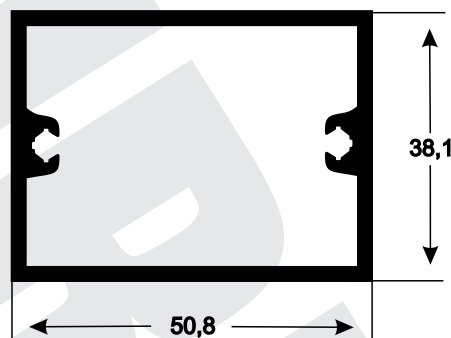

D-103
0,800 kg/m

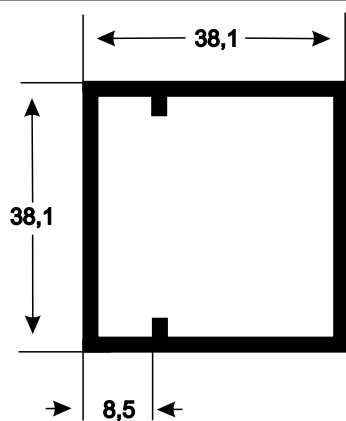

D-102
0,629 kg/m

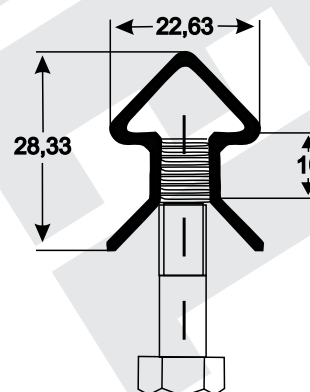

U-698
0,405 kg/m

ALUMIBEL

PERFIS DIVERSOS
PARA CAIXILHARIA

Comércio de Alumínio e Acessórios

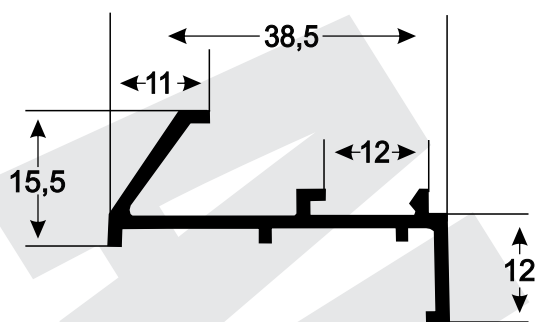

Z-063
0,314 kg/m

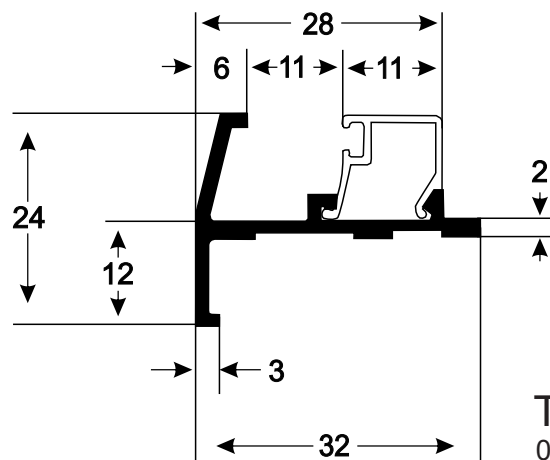

T-156
0,293 kg/m

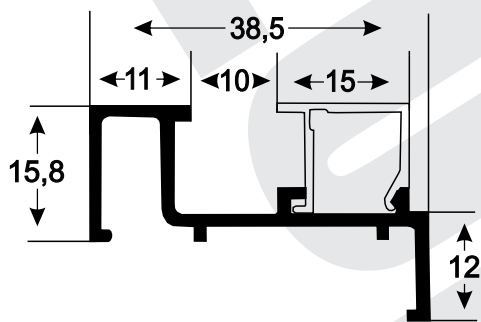

Z-062
0,350 kg/m

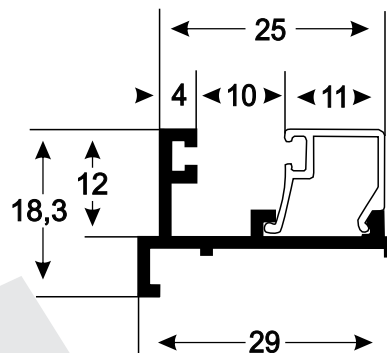

T-149
0,220 kg/m

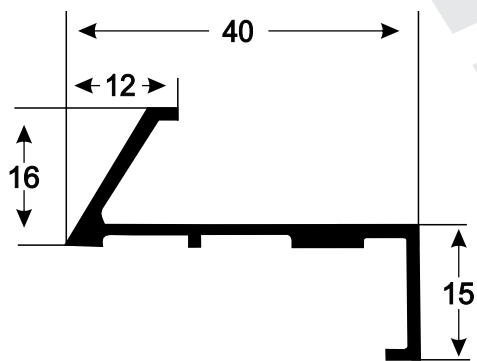

Z-033
0,351 kg/m

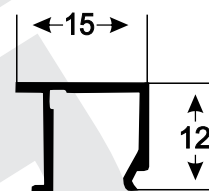

U-392
0,108 kg/m

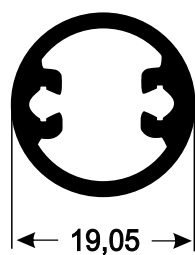

D-104
0,248 kg/m

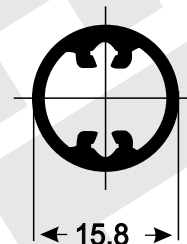

D-105
0,212 kg/m

ALUMIBEL

LAMBRIS

Comércio de Alumínio e Acessórios

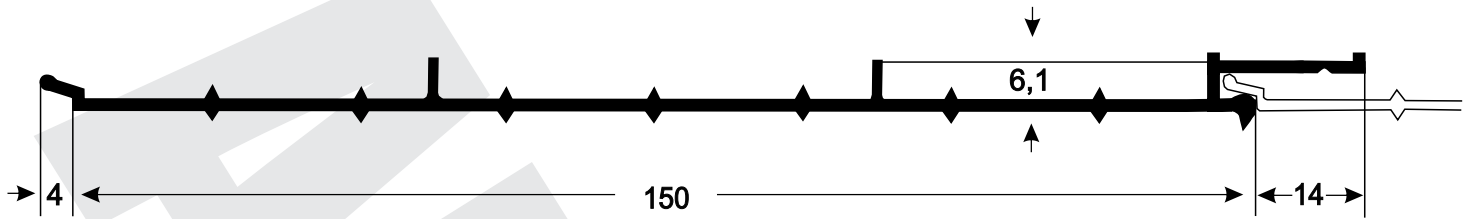

Y-336
0,565 kg/m

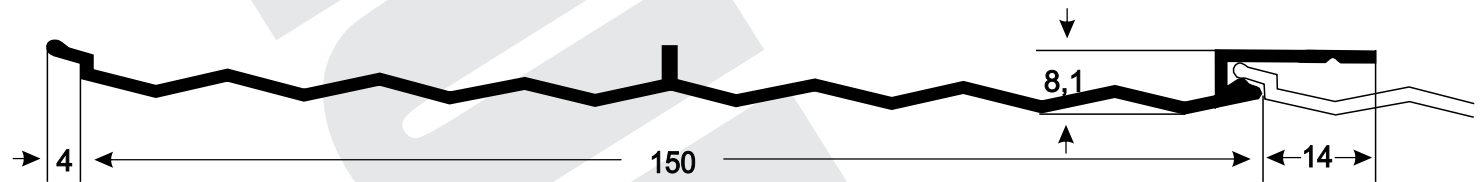

Y-333
0,865 kg/m

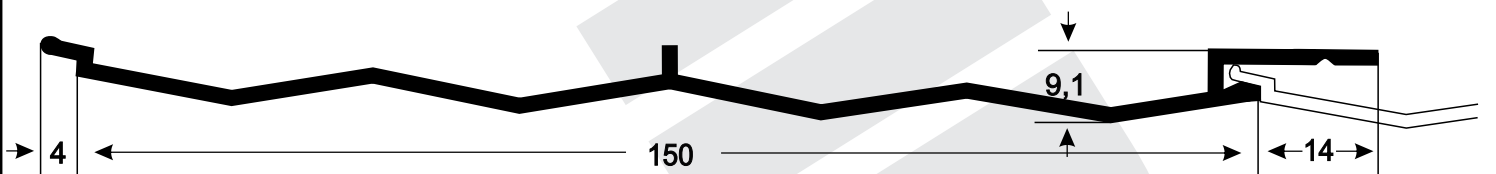

Y-330
0,860 kg/m

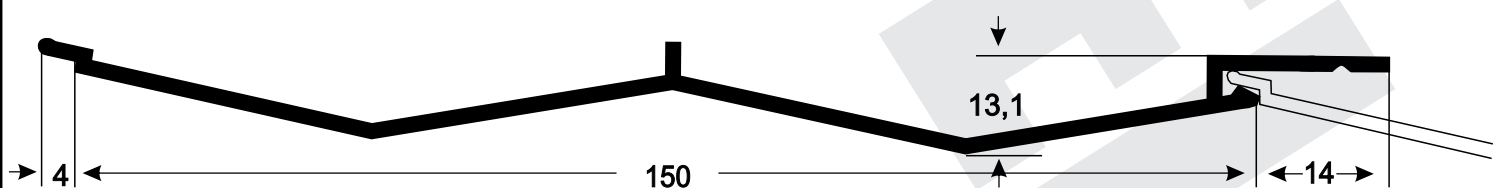

Y-331
0,870 kg/m

ALUMIBEL

Comércio de Alumínio e Acessórios

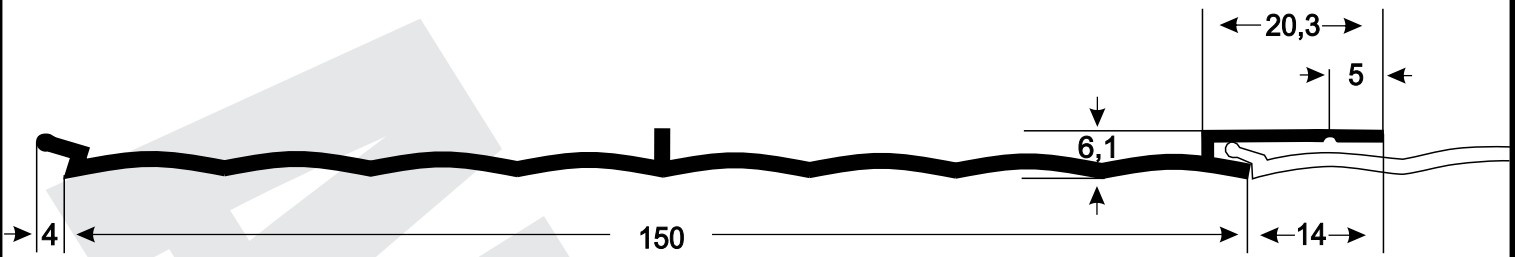

Y-334
0,840 kg/m



Y-332
0,850 kg/m

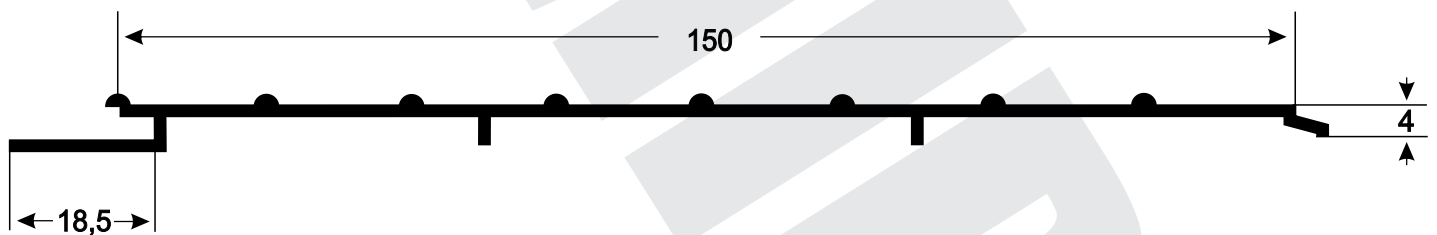

Y-430
0,686 kg/m

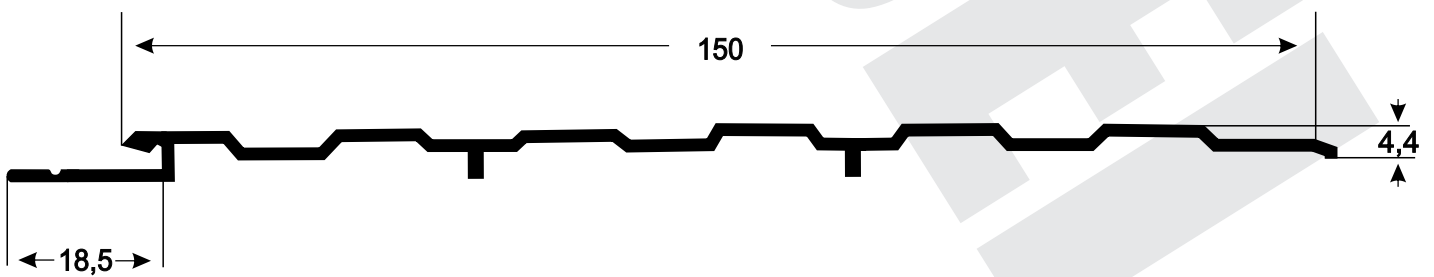

Y-429
0,669 kg/m

ALUMIBEL

LAMBRIS
E CANTOS

Comércio de Alumínio e Acessórios

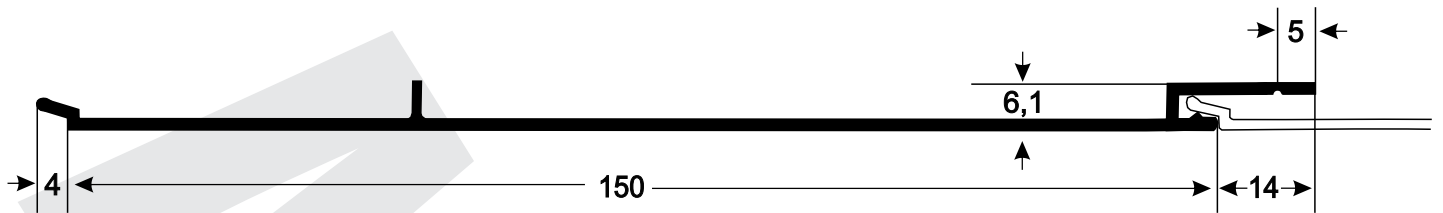

Y-335
0,840 kg/m

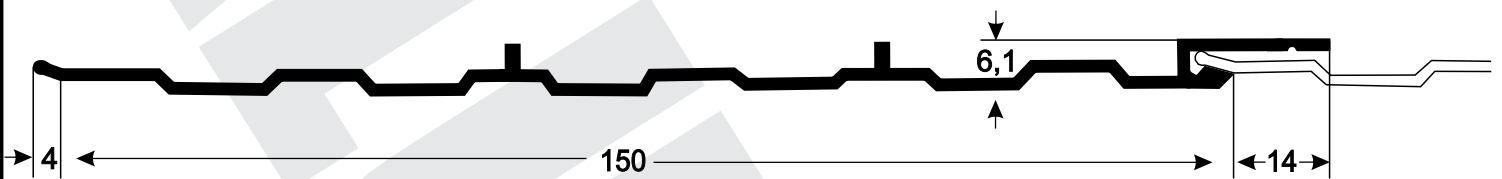

Y-354
0,866 kg/m



Y-355
0,921 kg/m



E-292
1,084 kg/m

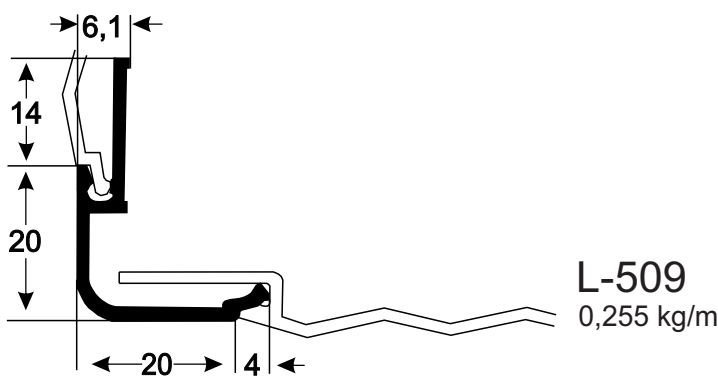

L-509
0,255 kg/m

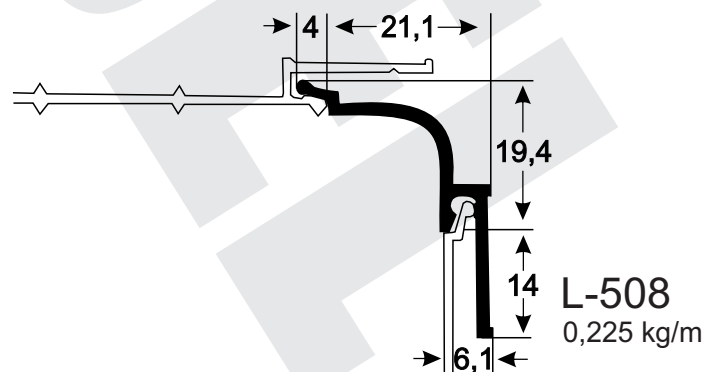

L-508
0,225 kg/m

ALUMIBEL

BALAUSTRADAS
E CORRIMÃOS

Comércio de Alumínio e Acessórios

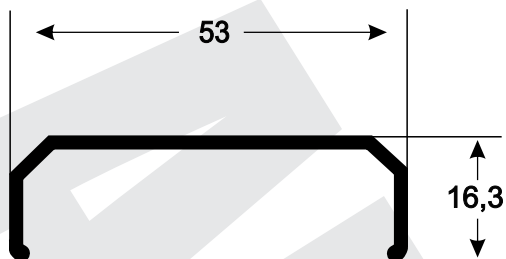

U-498
0,285 kg/m

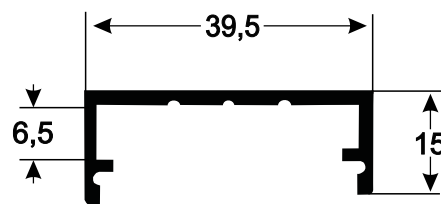

U-496
0,380 kg/m

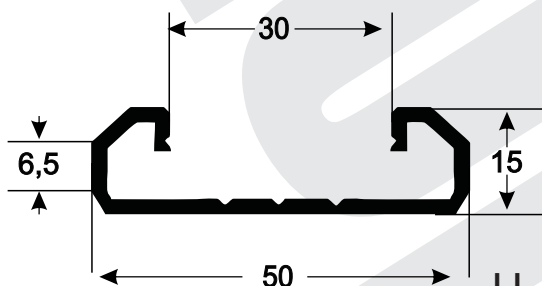

U-497
0,504 kg/m

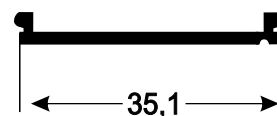

U-495
0,165 kg/m

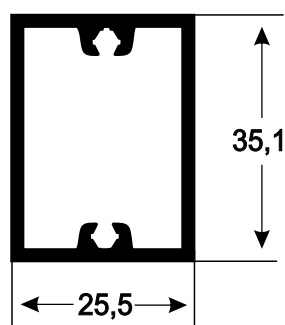

D-055
0,580 kg/m

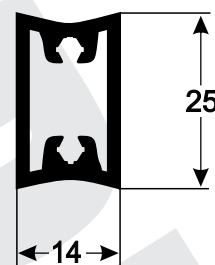

D-056
0,325 kg/m

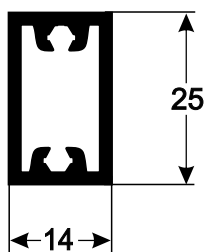

D-082
0,356 kg/m

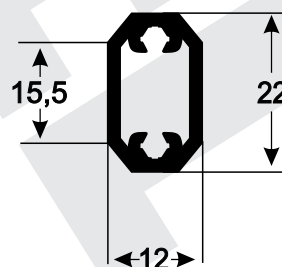

D-070
0,263 kg/m

ALUMIBEL

BALAUSTRADAS
E CORRIMÃOS

Comércio de Alumínio e Acessórios

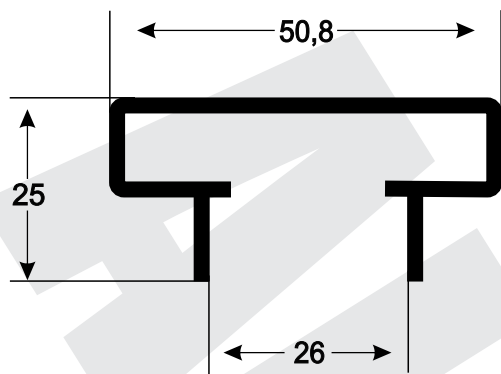

U-810
0,474 kg/m

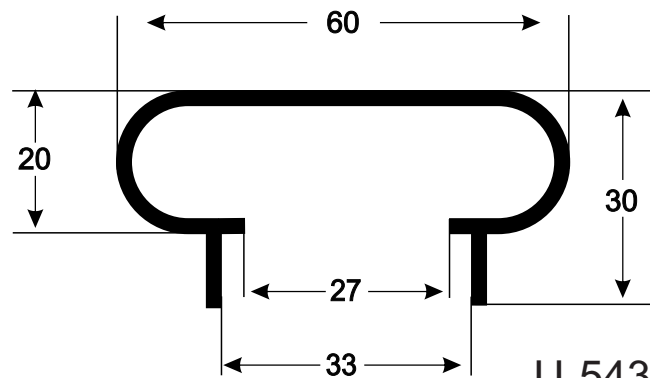

U-543
0,702 kg/m

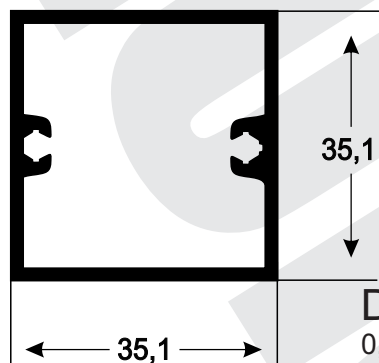

D-081
0,667 kg/m

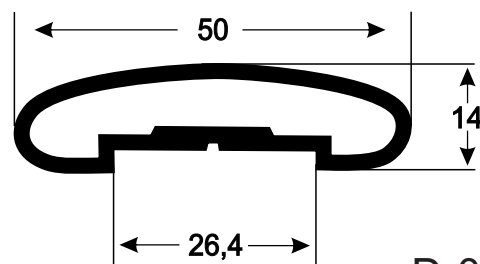

D-095
0,550 kg/m

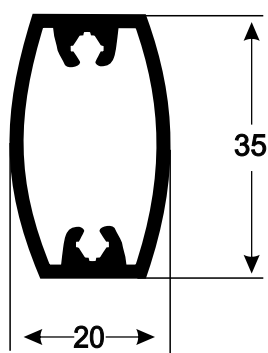

D-096
0,416 kg/m

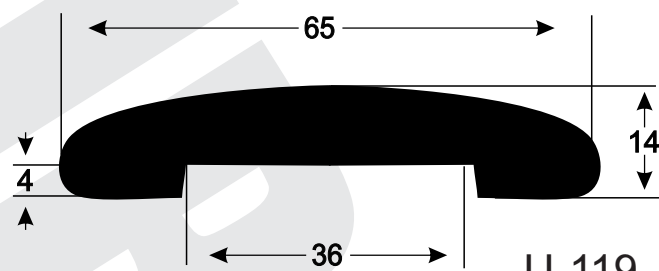

U-119
1,693 kg/m

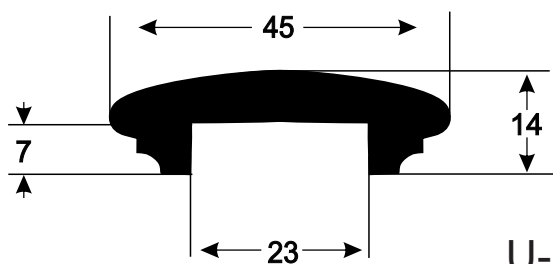

U-120
0,891 kg/m

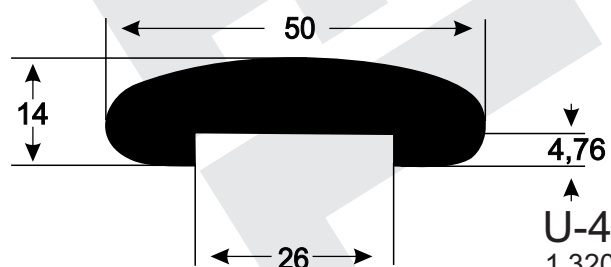

U-430
1,320 kg/m

ALUMIBEL

BOX
LISO

Comércio de Alumínio e Acessórios

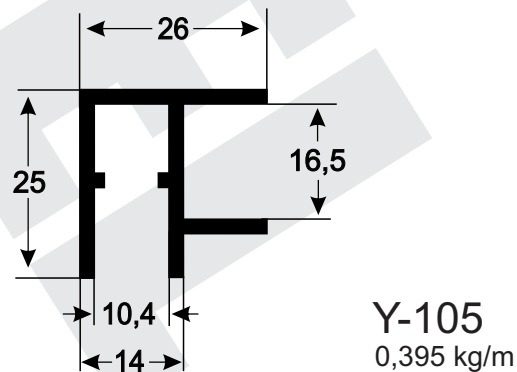
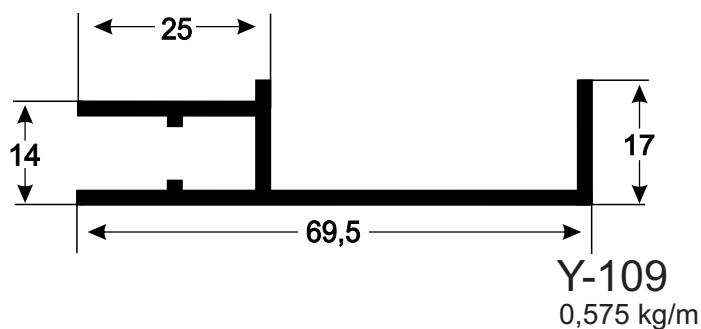
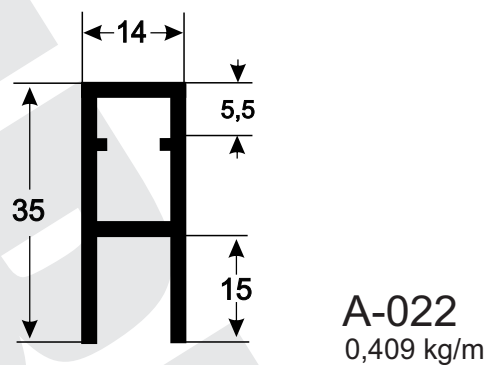
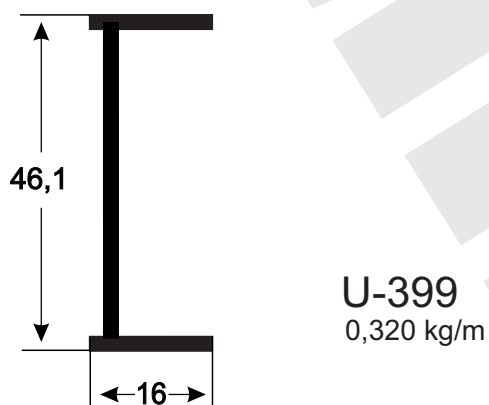
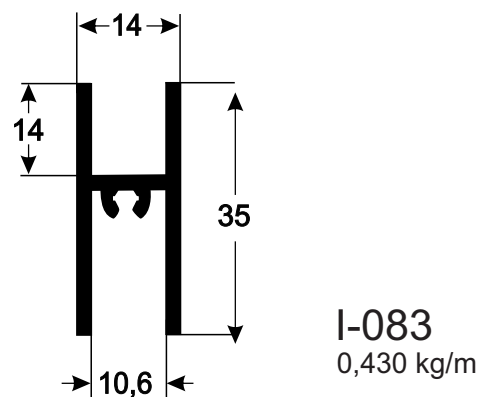
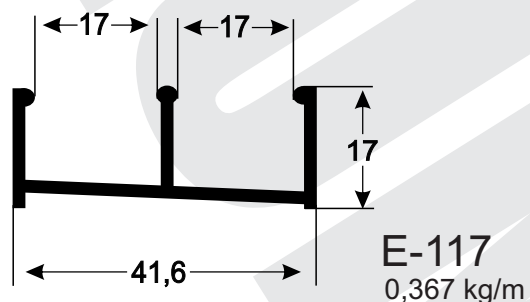
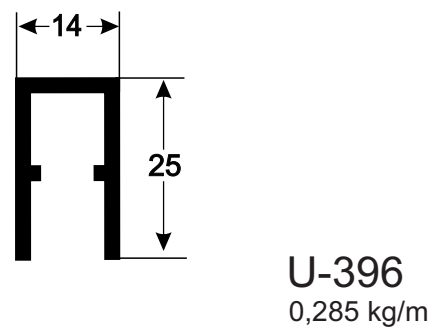
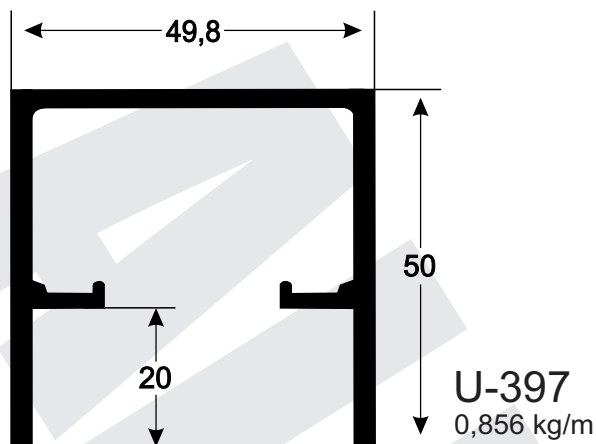

ALUMIBEL

BOX
LISO

Comércio de Alumínio e Acessórios

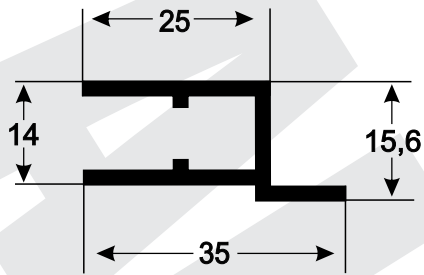

Y-106
0,335 kg/m

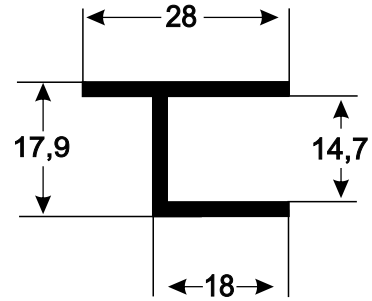

Y-107
0,280 kg/m

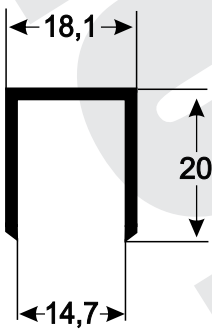

U-398
0,250 kg/m

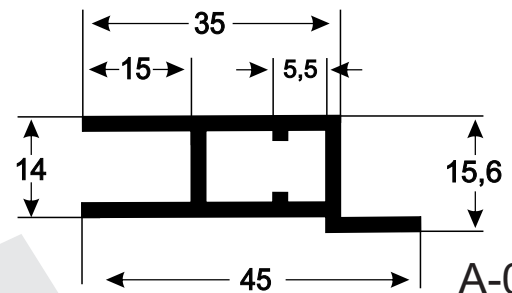

A-024
0,450 kg/m

ALUMIBEL

BOX
SÓ VIDRO

Comércio de Alumínio e Acessórios

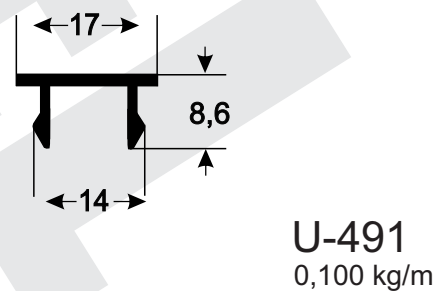
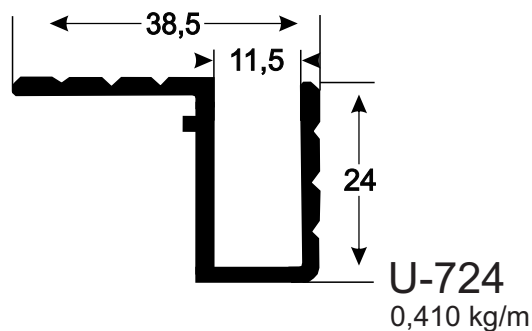
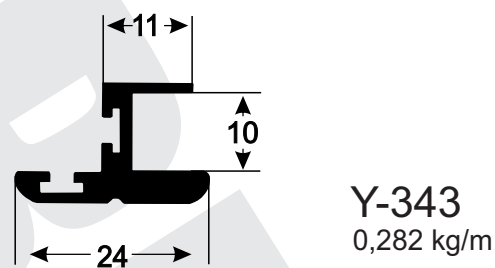
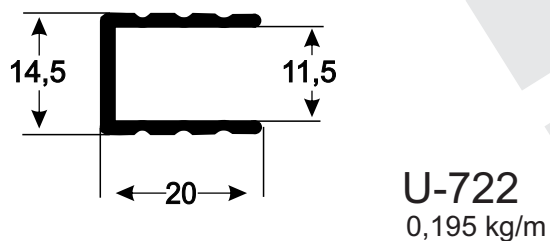
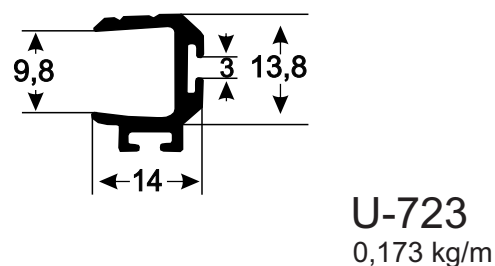
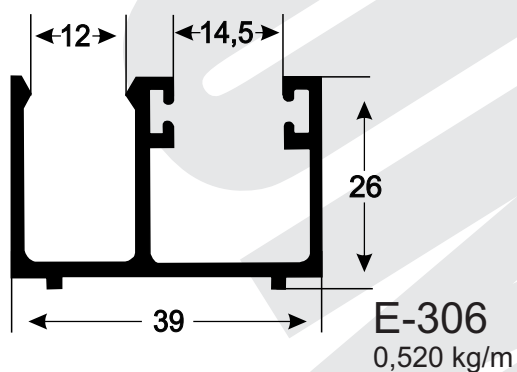
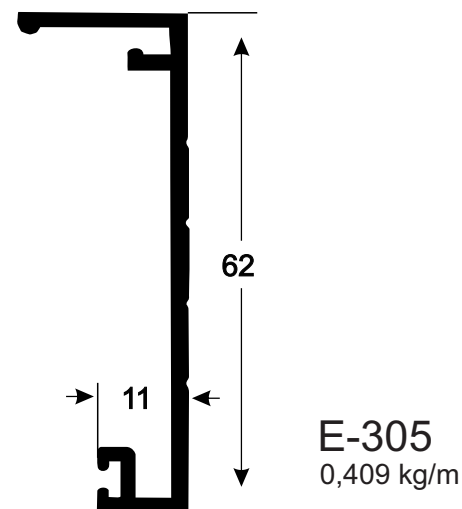
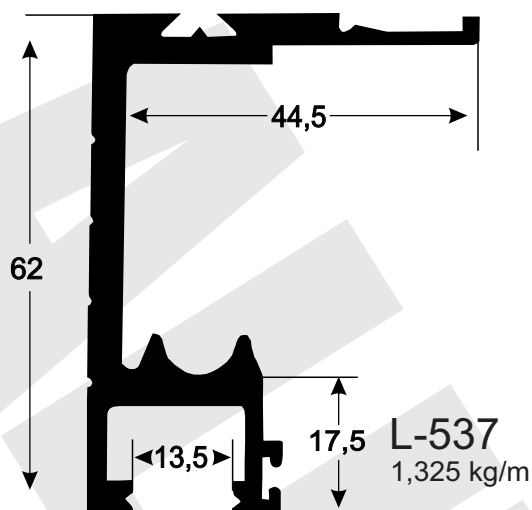

ALUMIBEL

TRILHOS E MOLDURAS

Comércio de Alumínio e Acessórios

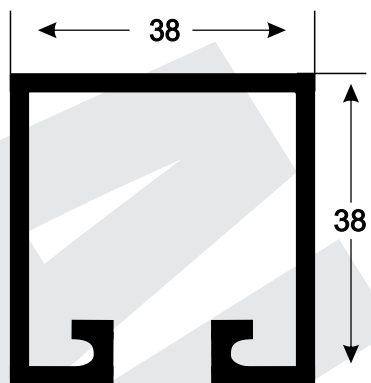

U-990
0,827 kg/m

U-990 A
0,635 kg/m

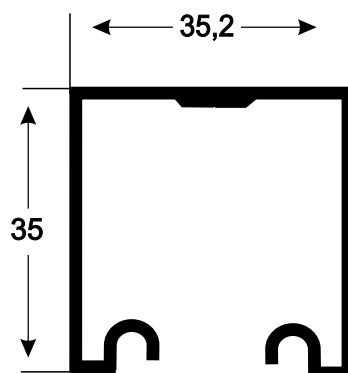

U-1098
0,494 kg/m

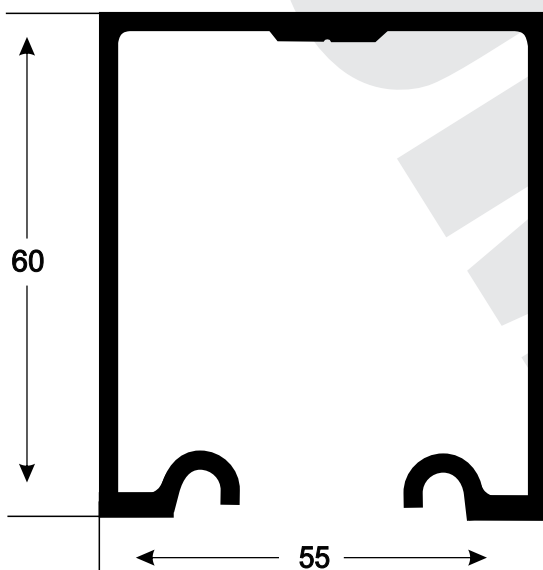

U-1048
1,453 kg/m

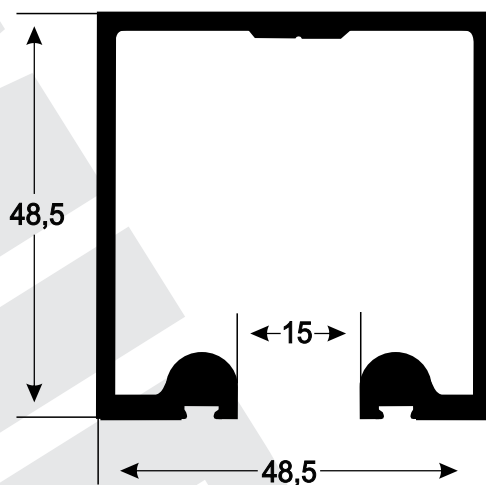

65-241D
1,308 kg/m

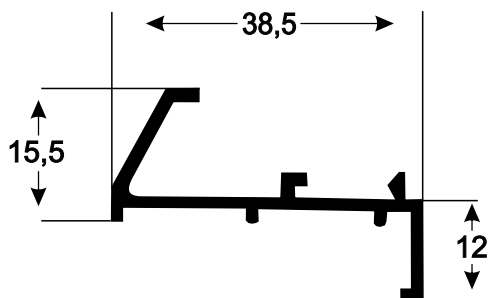

Z-063
0,325 kg/m

ALUMIBEL

PORTÃO
CAIXA LATERAL

Comércio de Alumínio e Acessórios

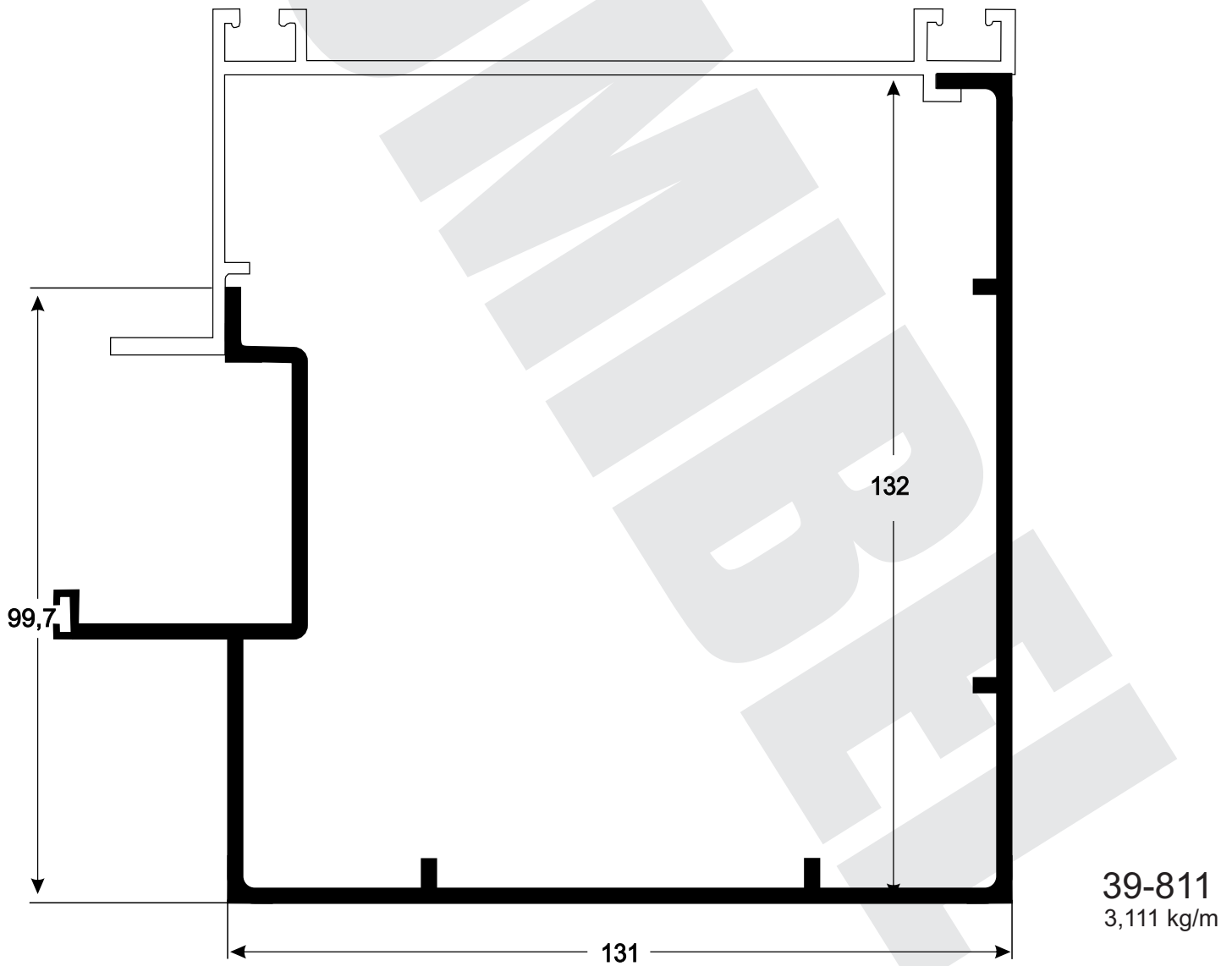
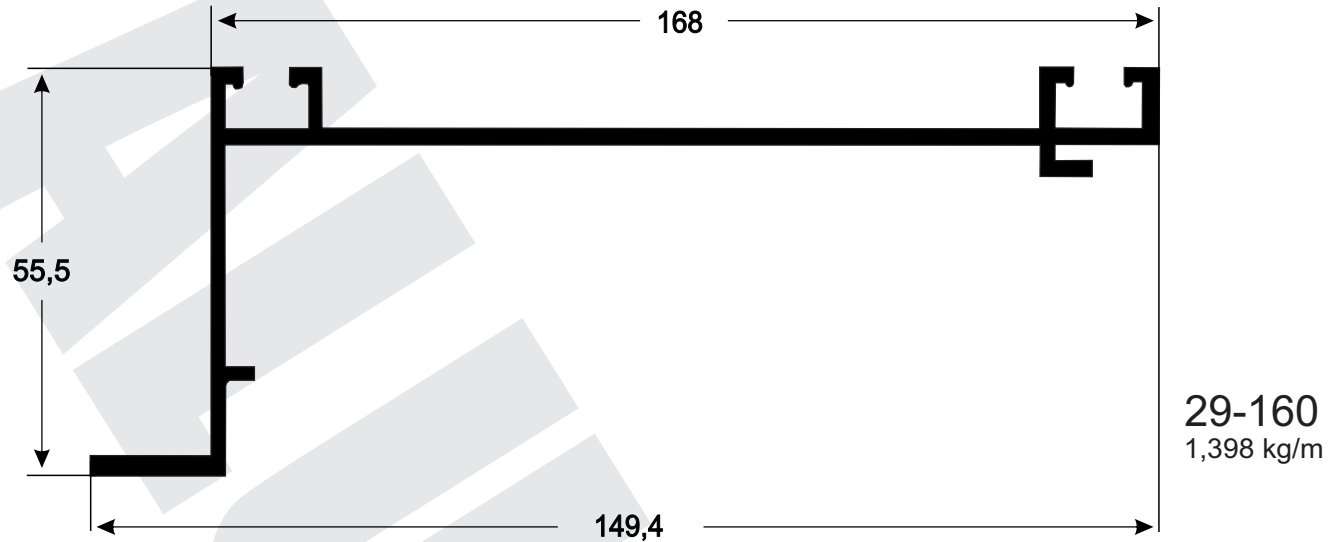

ALUMIBEL

Comércio de Alumínio e Acessórios

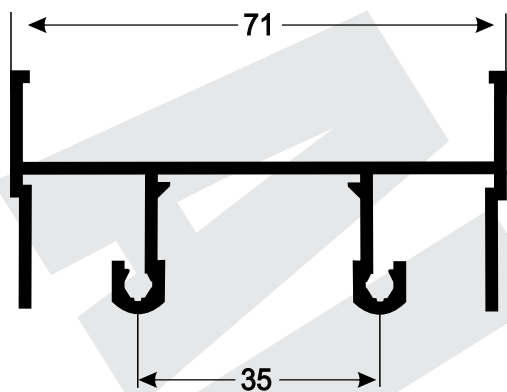

SU-001
0,773 kg/m

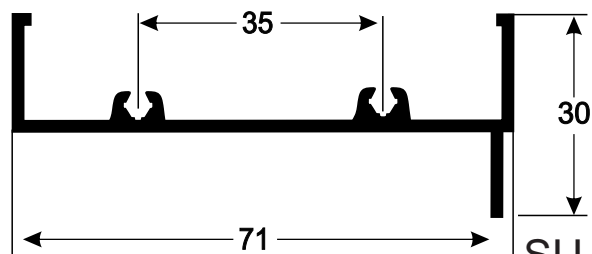

SU-004
0,526 kg/m

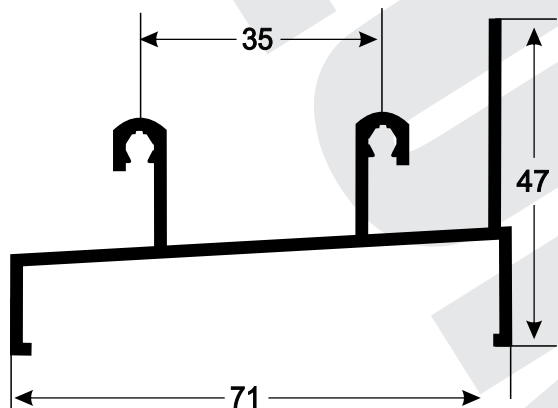

SU-002
0,711 kg/m

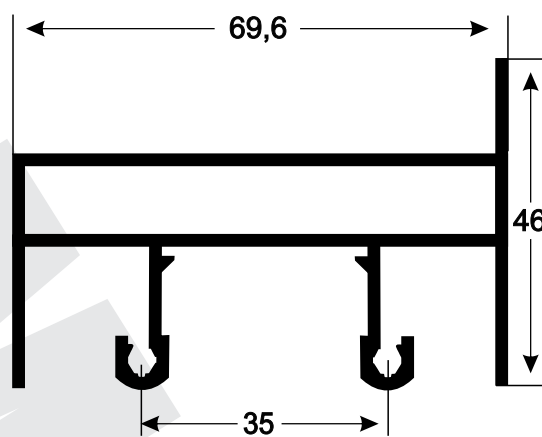

SU-005
1,106 kg/m

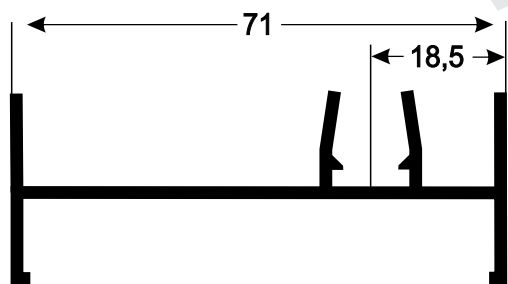

SU-003
0,537 kg/m

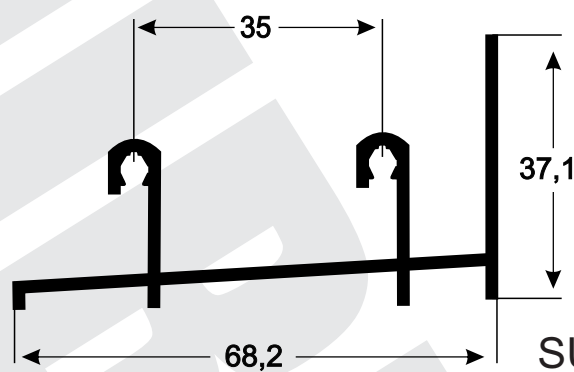

SU-228
0,718 kg/m

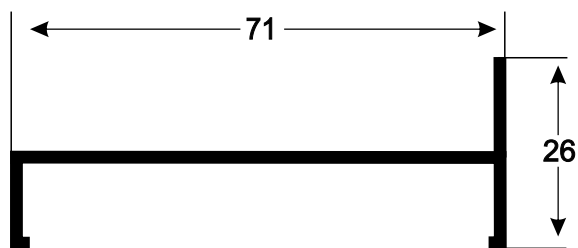

SU-007
0,386 kg/m

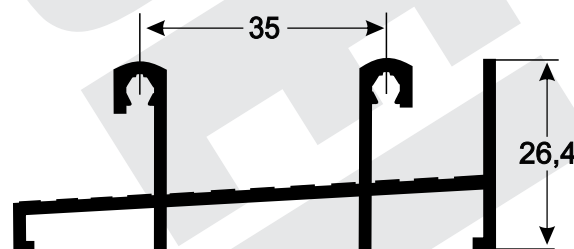

E-578
0,707 kg/m

ALUMIBEL

Comércio de Alumínio e Acessórios

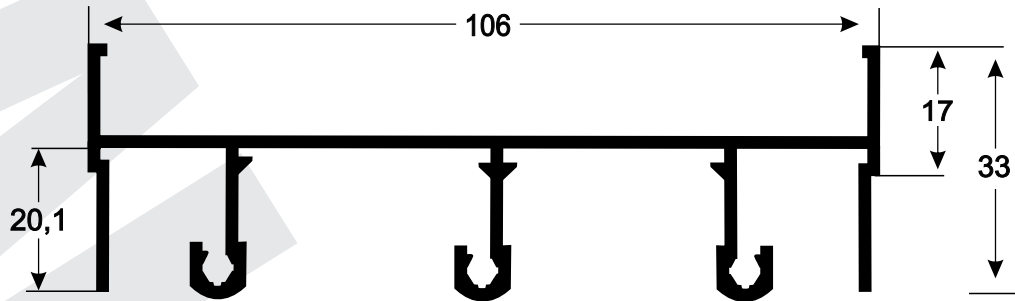

SU-010
1,028 kg/m

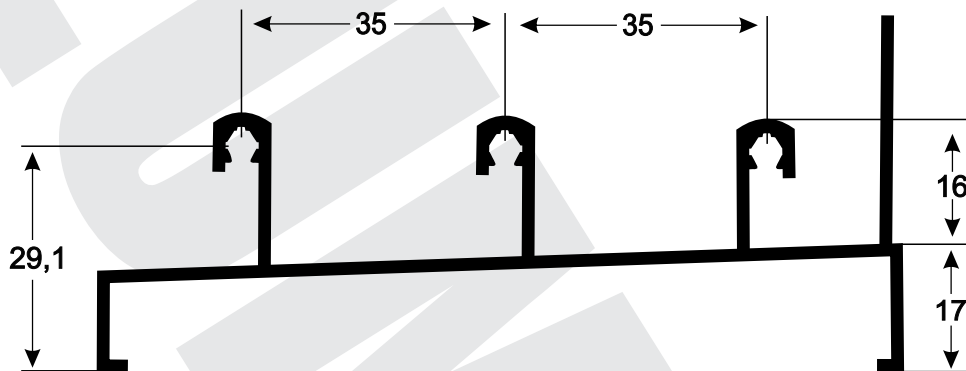

SU-011
0,960 kg/m

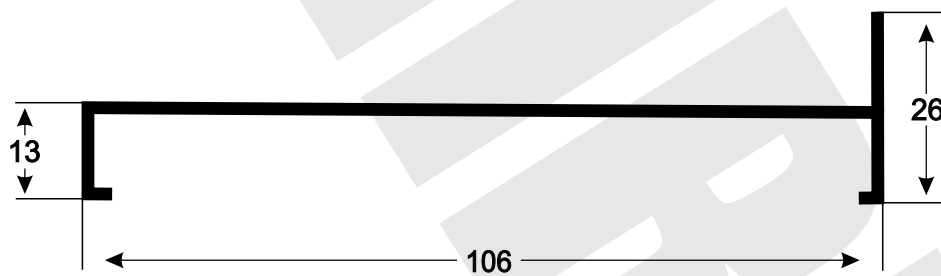

SU-012
0,559 kg/m

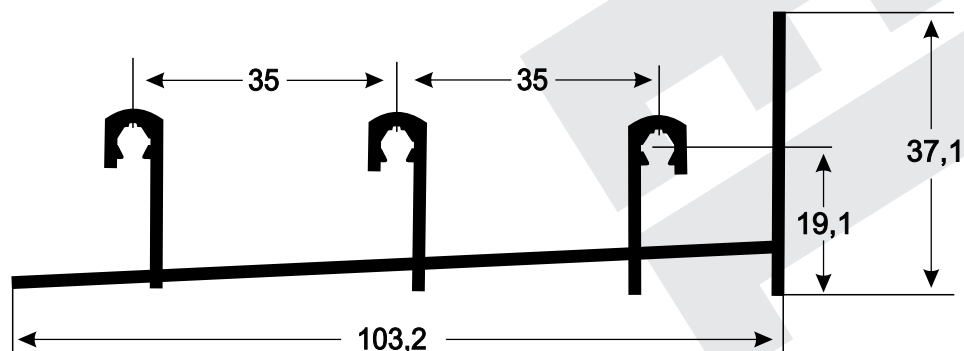

SU-230
0,976 kg/m

ALUMIBEL

Comércio de Alumínio e Acessórios

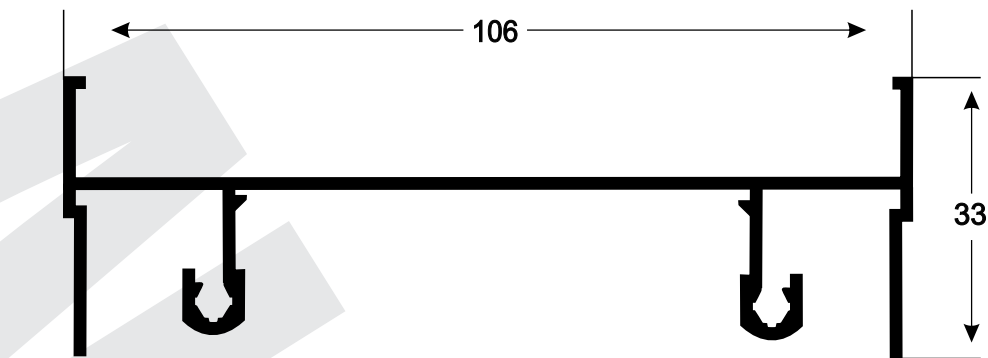

SU-015
0,918 kg/m

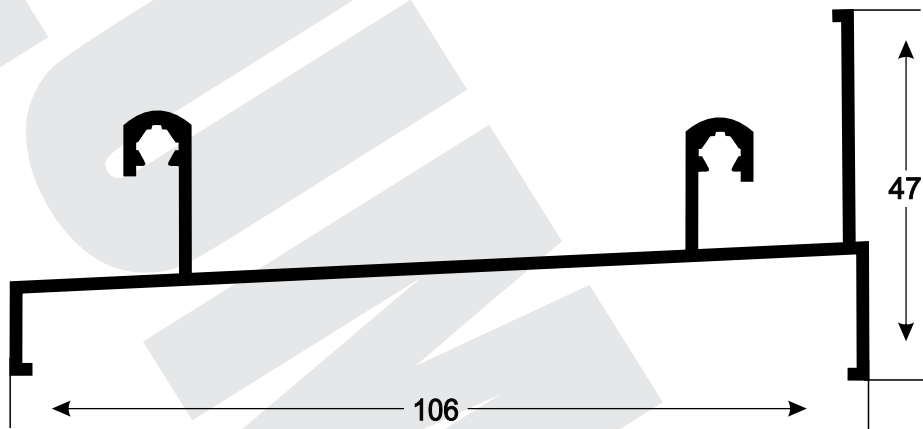

SU-016
0,841 kg/m

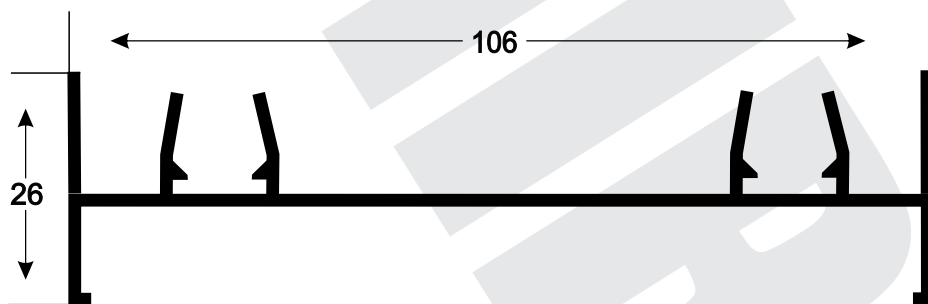

SU-013
0,767 kg/m

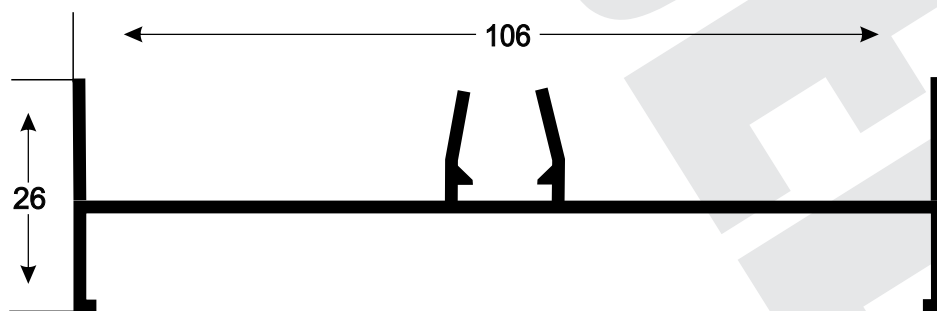

SU-014
0,674 kg/m

ALUMIBEL

Comércio de Alumínio e Acessórios

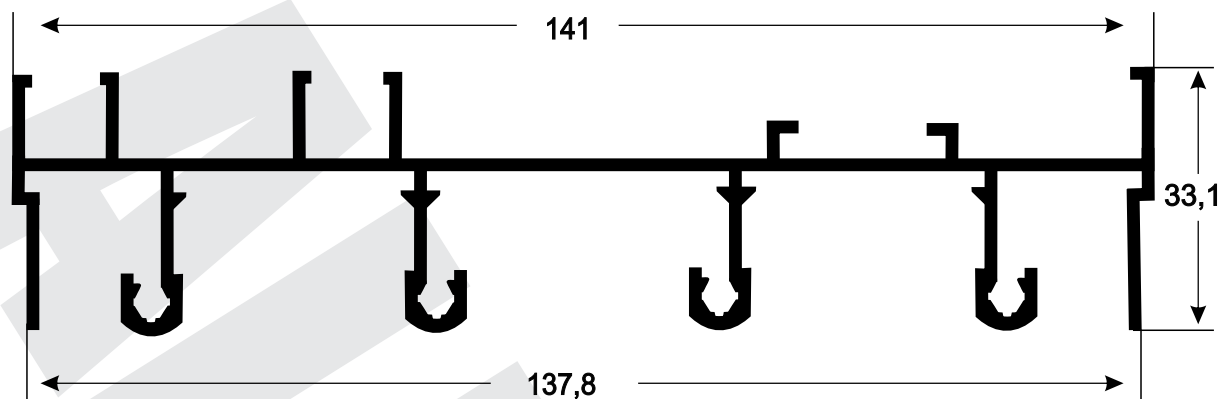

SU-121
1,585 kg/m

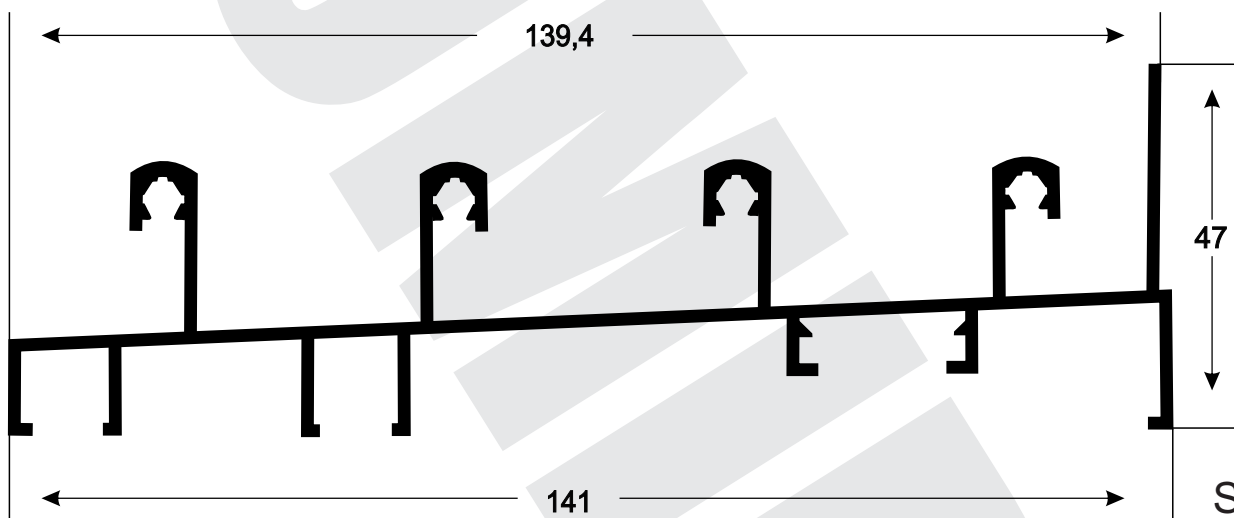

SU-122
1,509 kg/m

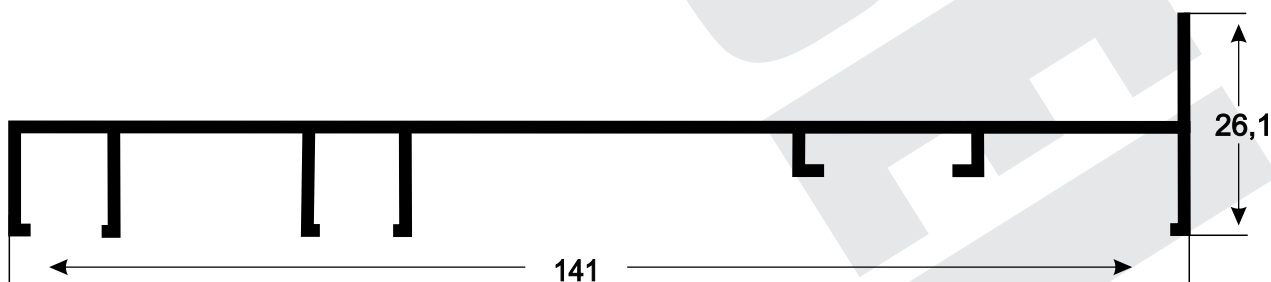

SU-123
0,917 kg/m

ALUMIBEL

Comércio de Alumínio e Acessórios

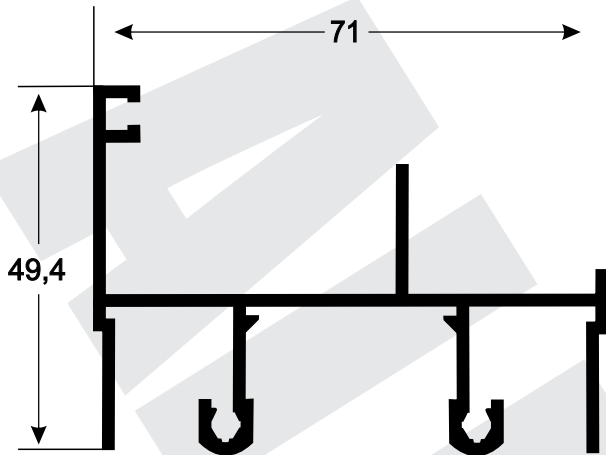

SU-026
0,855 kg/m

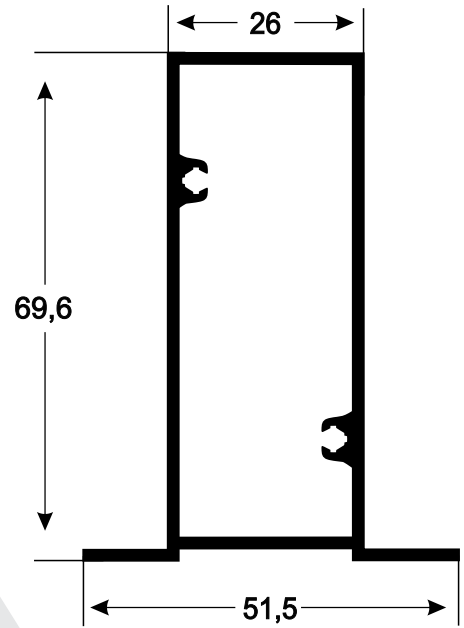

SU-009
0,907 kg/m

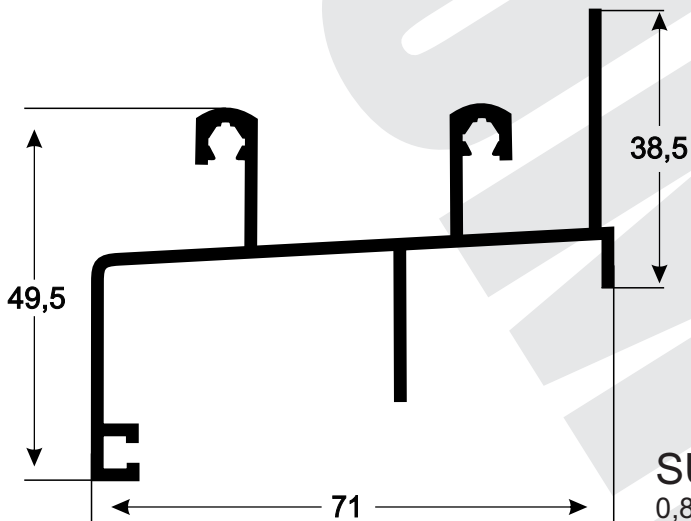

SU-027
0,803 kg/m

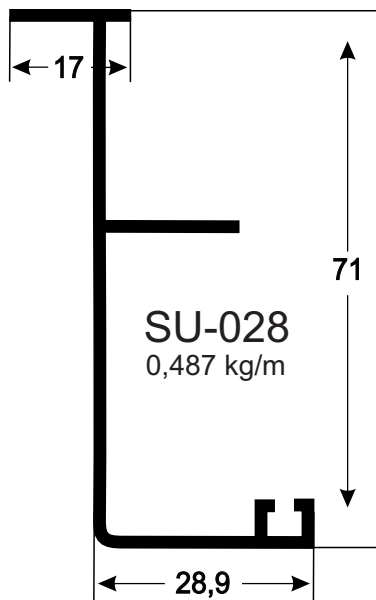

SU-028
0,487 kg/m

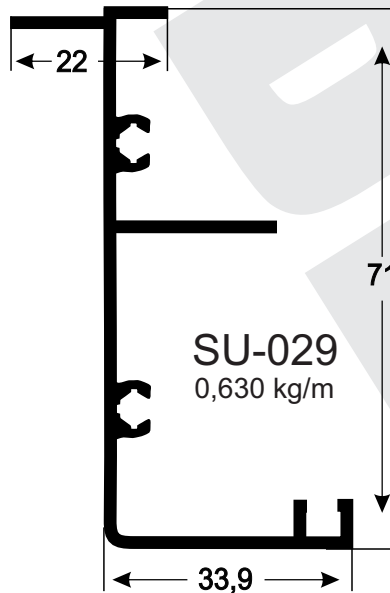

SU-029
0,630 kg/m

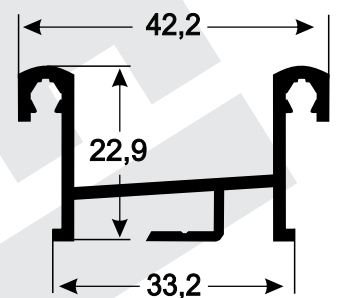

SU-272
0,430 kg/m

ALUMIBEL

Comércio de Alumínio e Acessórios

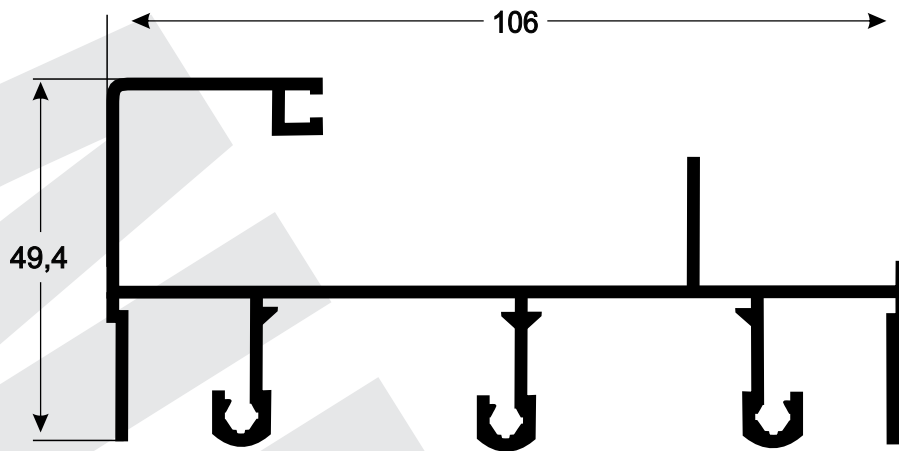

SU-031
1,200 kg/m

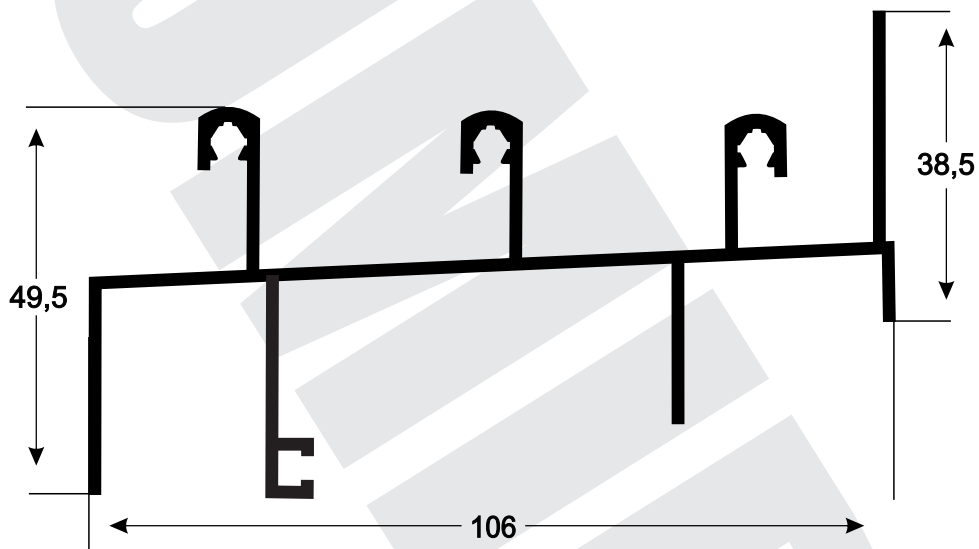

SU-032
1,137 kg/m

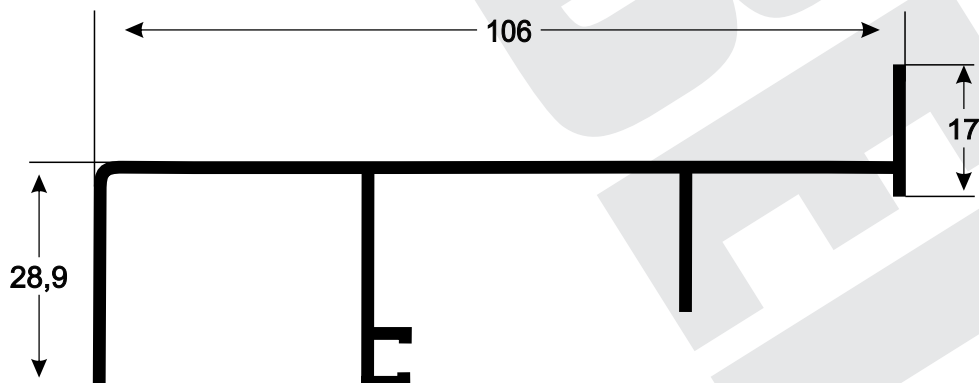

SU-033
0,703 kg/m

ALUMIBEL

Comércio de Alumínio e Acessórios

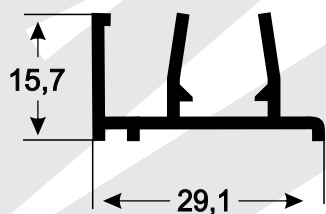

SU-008
0,245 kg/m

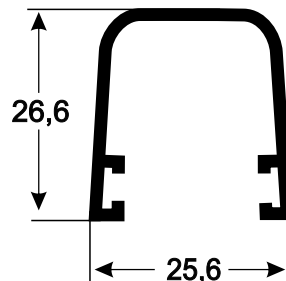

SU-107
0,263kg/m

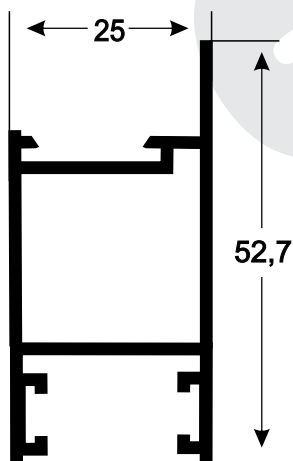

SU-039
0,554 kg/m

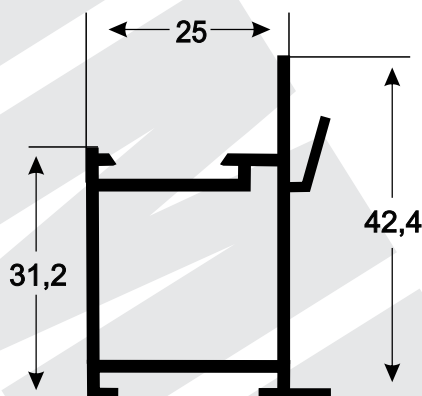

SU-040
0,493 kg/m

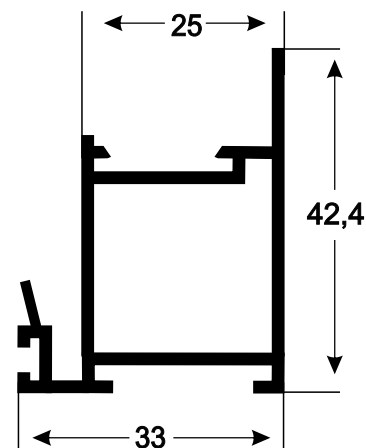

SU-041
0,532 kg/m

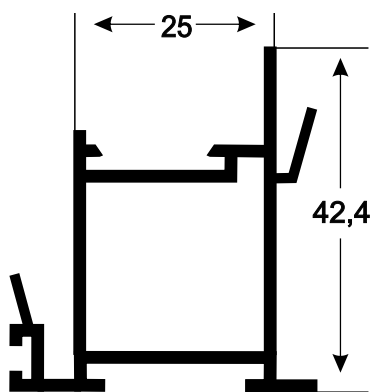

SU-042
0,589 kg/m

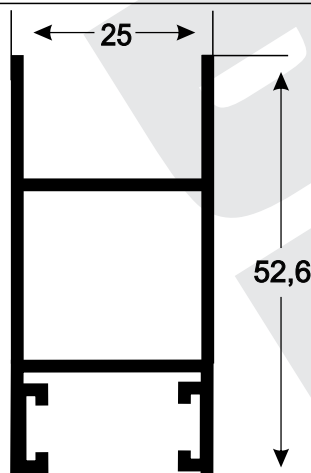

SU-068
0,575 kg/m

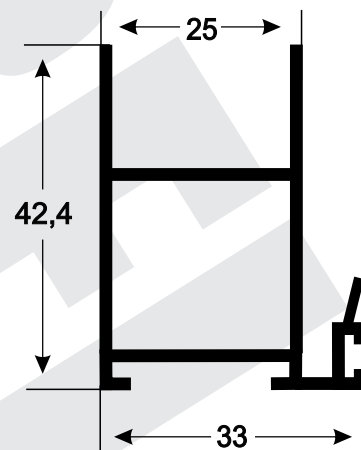

SU-070
0,560 kg/m

ALUMIBEL

Comércio de Alumínio e Acessórios

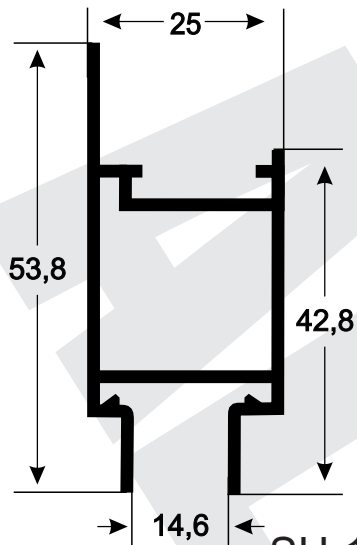

SU-192
0,554 kg/m

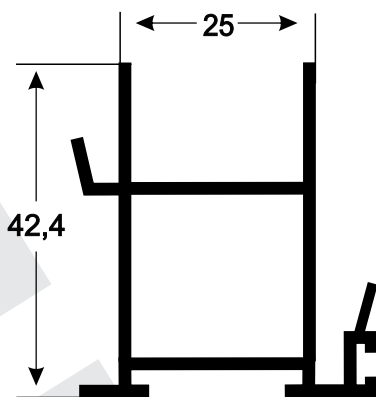

SU-069
0,614 kg/m

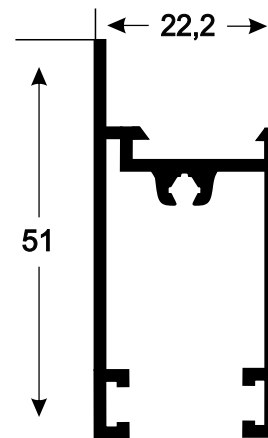

SU-053
0,542 kg/m

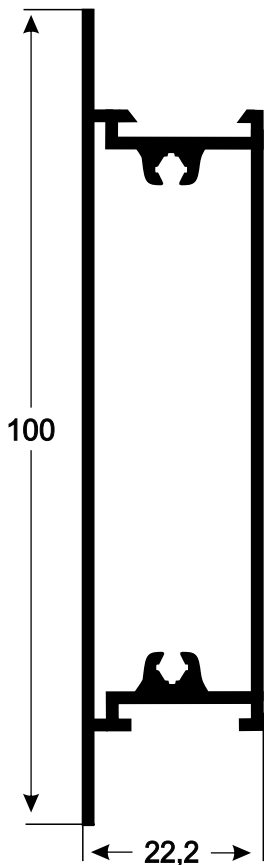

SU-050
0,925 kg/m

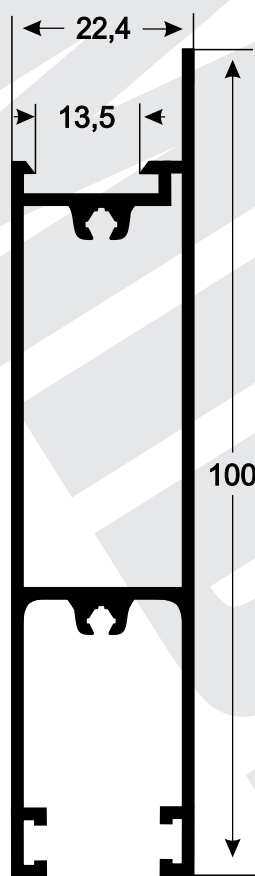

SU-225
0,926 kg/m

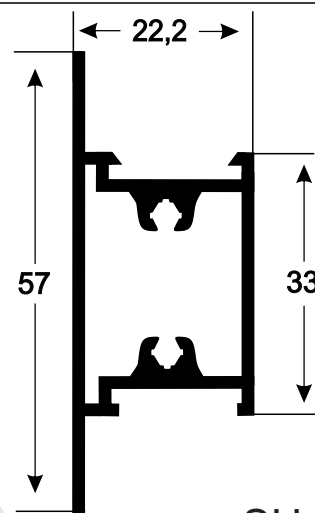

SU-227
0,574 kg/m

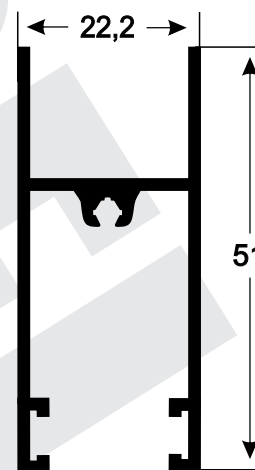

SU-187
0,534 kg/m

ALUMIBEL

Comércio de Alumínio e Acessórios

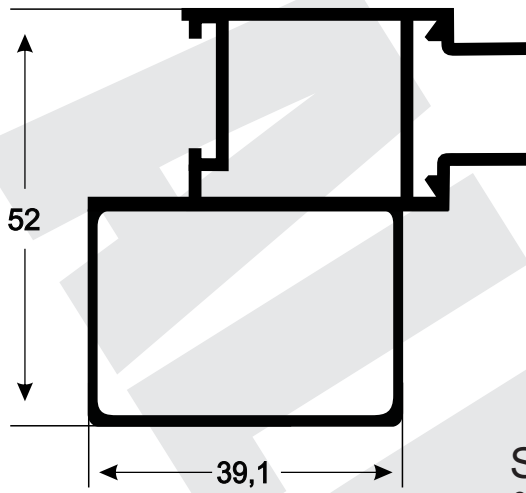

SU-043
0,998 kg/m

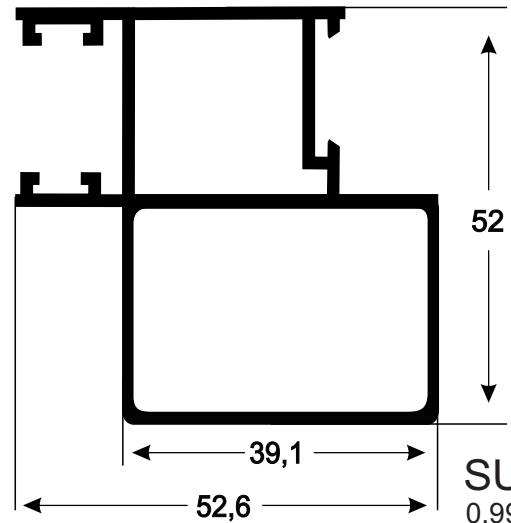

SU-044
0,997 kg/m

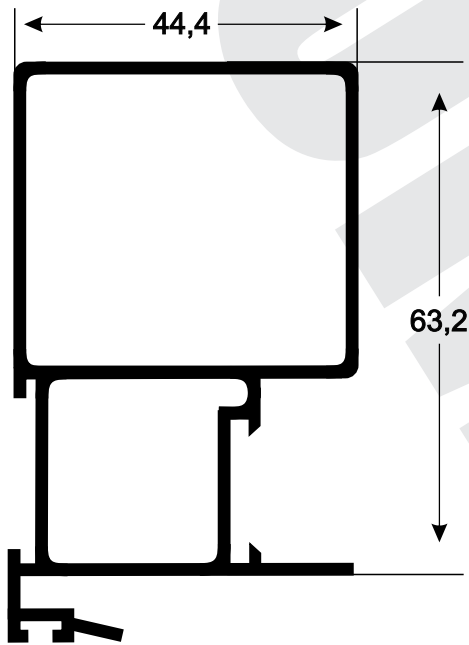

SU-049
0,997 kg/m

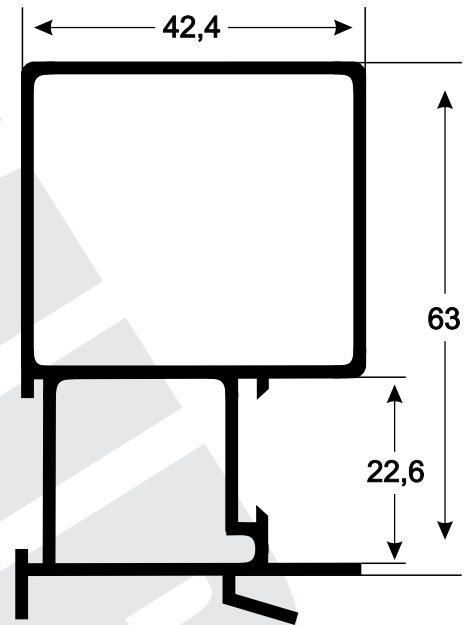

SU-047
1,041 kg/m

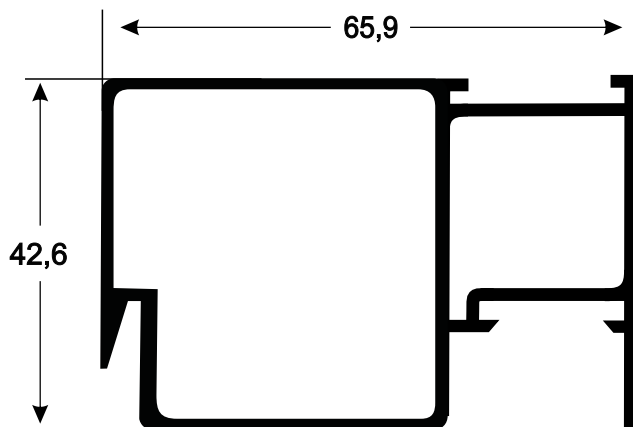

SU-048
1,056 kg/m

ALUMIBEL

Comércio de Alumínio e Acessórios

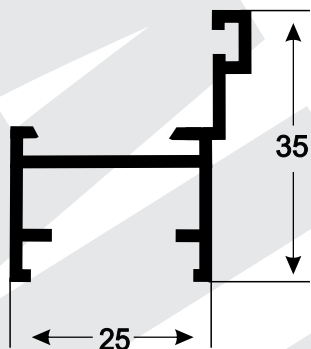

SU-079
0,333 kg/m

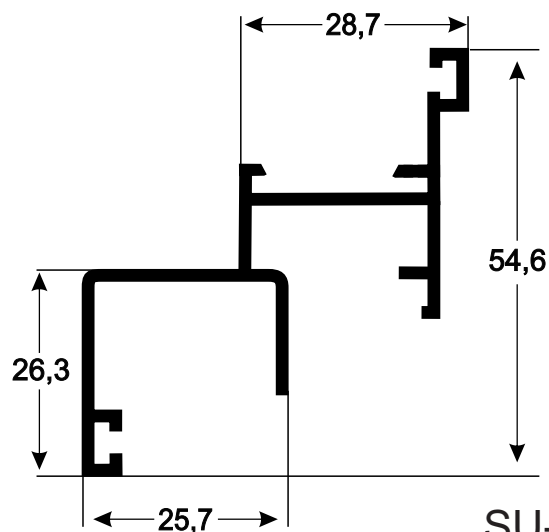

SU-030
0,541 kg/m

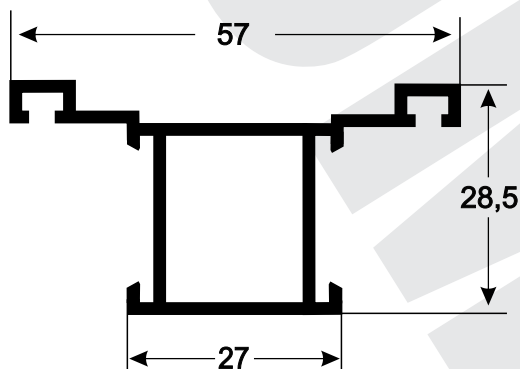

SU-085
0,506 kg/m

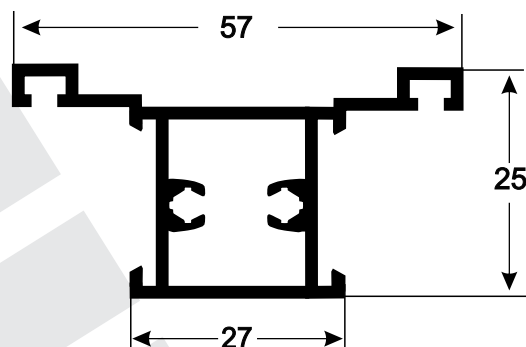

SU-086
0,589 kg/m

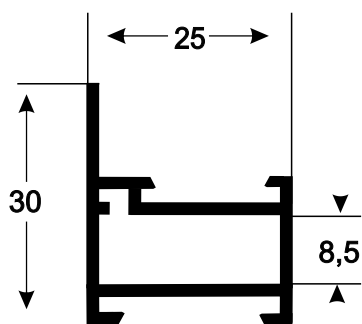

SU-080
0,362 kg/m

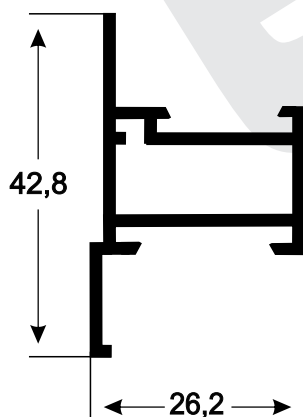

SU-081
0,420 kg/m

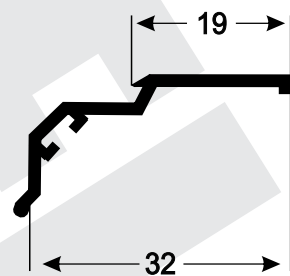

SU-083
0,144 kg/m

ALUMIBEL

Comércio de Alumínio e Acessórios

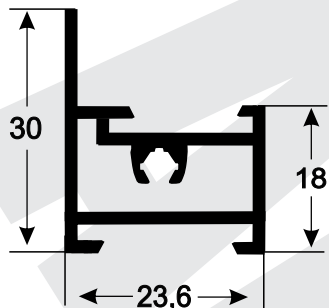

SU-082
0,389 kg/m

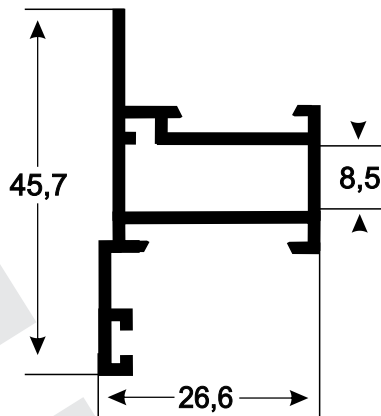

SU-200
0,440 kg/m

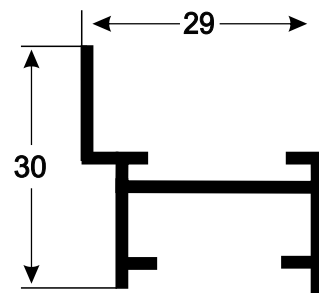

Y-782
0,278 kg/m

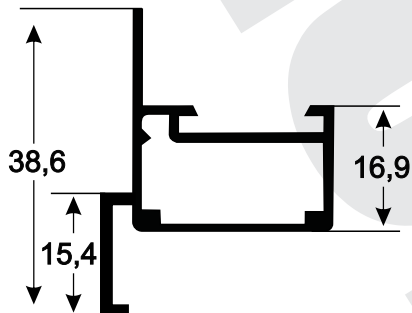

SU-097
0,391 kg/m

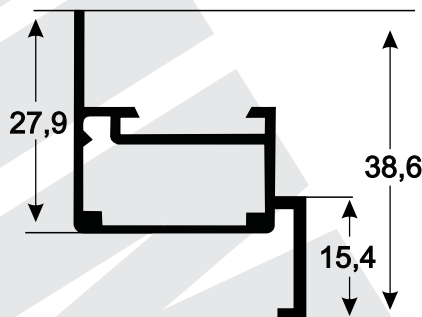

SU-098
0,391 kg/m

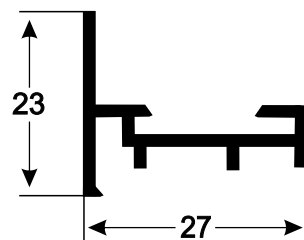

SU-099
0,223 kg/m

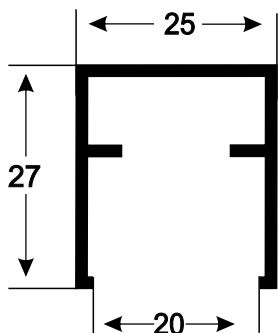

SU-093
0,274 kg/m

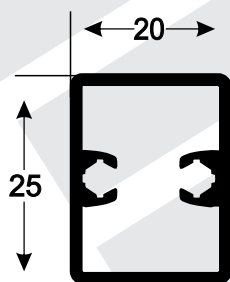

SU-094
0,354 kg/m

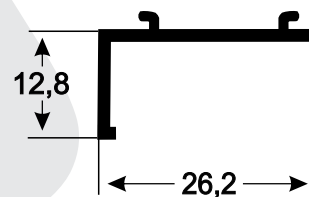

L-795
0,124 kg/m

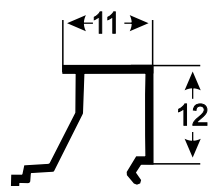

SU-102
0,110 kg/m

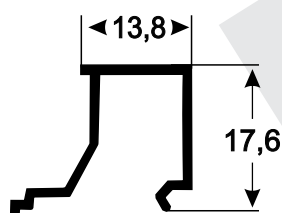

SU-103
0,156 kg/m

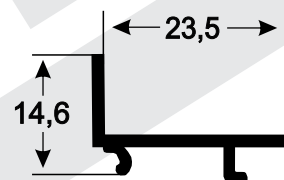

SU-292
0,142 kg/m

ALUMIBEL

Comércio de Alumínio e Acessórios

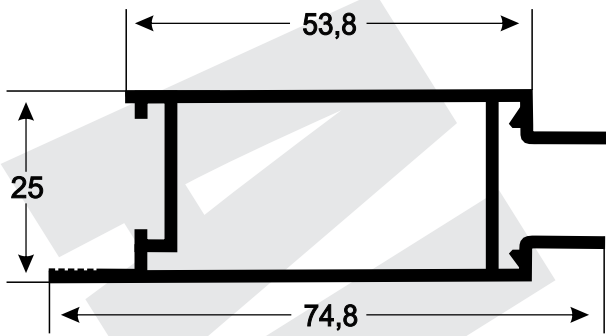

SU-224
0,685 kg/m

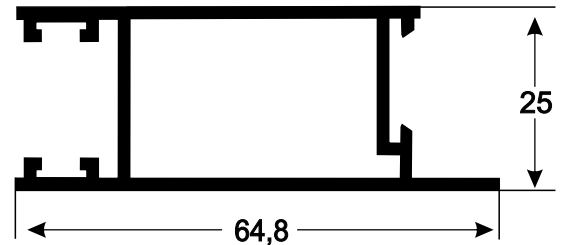

SU-245
0,634 kg/m

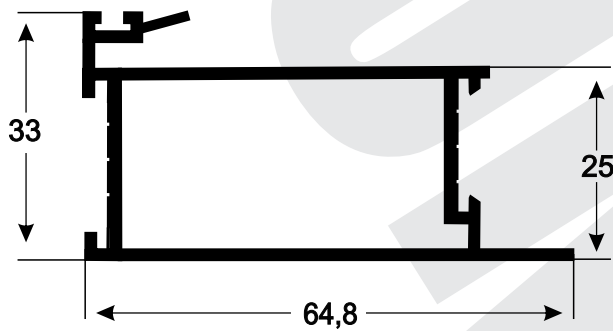

SU-242
0,660 kg/m

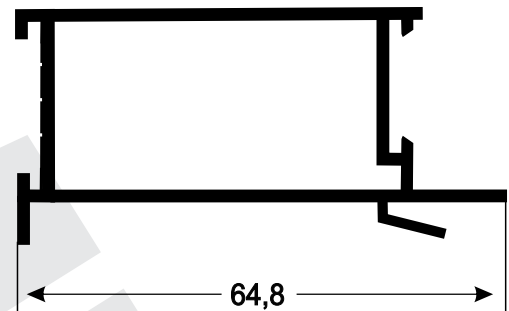

SU-243
0,620 kg/m

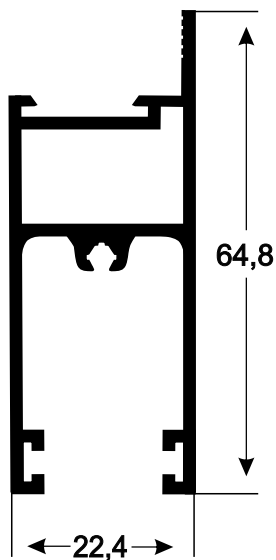

SU-246
0,632 kg/m

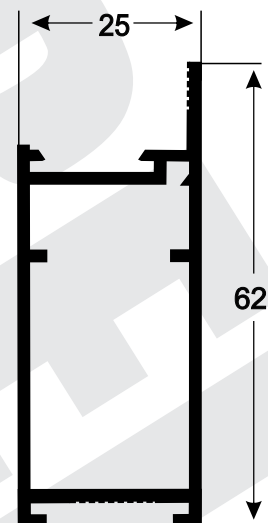

SU-111
0,621 kg/m